

Cygnus DIVE

Ultrasonic Thickness Gauge for Divers

Operation Manual



Covers Gauge Model: M3-DIVE

Doc No. M3-DIVE-M-ENG_Iss10.docx
November 2022
(Mk3 DIVE Gauges)

Contents

1. Introduction.....	7
Cygnus DIVE Underwater Thickness Gauge.....	7
Cygnus Instruments.....	8
Contact Details.....	8
Gauge Kit Contents.....	9
2. The DIVE Gauge.....	10
Features of the DIVE Gauge.....	10
Fitting the DIVE Gauge.....	10
3. Batteries.....	13
Important Notes.....	13
Use in Hyperbaric Conditions.....	13
Shipping of Lithium Batteries.....	13
Fitting the Battery.....	13
Removing the Battery.....	14
Charging the Battery.....	15
4. Fitting the Ultrasonic Probe.....	16
Important – Cap Fitment.....	16
Connecting the Probe.....	16
Probe Calibration Check Message.....	17
Securing the Probe while Diving.....	18
5. Ultrasonic Probes (Transducers).....	19
Important Notes.....	19
Probe Types.....	19
Single Element Probes.....	19
Twin Element Probes.....	20
Identifying Single or Twin Element Probes.....	20
Probe Identification Band.....	21
Probe Frequencies.....	21
Probe Measurement Ranges.....	22
Probe Selection Chart.....	24
Single Element Probes and Protective Membranes.....	25
Changing the Protective Membrane on Single Element Probes.....	27
Automatic Probe Type Detection.....	28
Twin Element Probe Wear Indication.....	28
6. Measure Modes.....	29
Multiple Echo Mode (ME).....	29

Single Echo Mode (SE)	29
Echo-Echo Mode (EE)	30
Measuring Small Diameter Pipe & Tubes.....	31
7. Why should I Calibrate my Thickness Gauge?	32
8. Using the DIVE Gauge	33
Turning the Gauge On	33
Zeroing the Probe (twin crystal)	34
Turning the Gauge Off	34
Before Each Dive	35
The Measurement Screen.....	36
No Probe Connected Message	36
Low Battery Level	37
Displaying Thickness Measurements	37
The A-Scan Display	37
A-Scan Display in Single Echo Mode.....	38
Surface Preparation	38
Taking a Thickness Measurement	40
Measuring Small Pipe with Twin Crystal Probes.....	40
Signal Strength Indication.....	40
Echo Bars in Multiple Echo Mode	41
Stability Indication in Single Echo & Echo-Echo Modes.....	42
9. Interpreting the A-Scan Display in Multiple Echo Mode... 43	
Pits and Flaws	44
Heavy Corrosion.....	45
10. Interpreting the A-Scan Display in Single Echo Mode ..47	
Measuring Over Corrosion Pits	49
11. Interpreting the A-Scan Display in Echo-Echo Mode50	
12. Changing Gauge Settings.....52	
The Two Button System.....	52
Button Functions in Menus	52
Button Functions in Setup Screens.....	53
Gauge Settings Saved with Probe Type	53
Displaying the Menu.....	54
Menu Tree Diagram	55
Data Logging Menu (DATA LOG MENU).....	56
A-Scan Range Setting (A-SCAN RANGE)	56
Turning the A-Scan Display On or Off (A-SCAN DISPLAY)	57
Setting the Velocity of Sound (VELOCITY).....	57
Calibrating to a Known Thickness (CALIBRATE)	58

Two Point Calibration (CALIBRATE 2 POINT).....	59
Ladder Step Wedge	59
Two Point Calibration Procedure	60
Zeroing the Twin Crystal Probe (ZERO PROBE)	61
Material Velocity of Sound List (MATERIAL LIST).....	63
Measurement Units (UNITS)	64
Thickness Measurement Resolution (RESOLUTION)	64
Multiple Echo Mode	64
Single Echo and Echo-Echo Modes	64
Deep Coat Feature (DEEP COAT)	65
Changing the Measurement Mode (MEASURE MODE)	65
Probe Type Selection (PROBE TYPE).....	66
Setting the Power Save Timer (POWER-SAVE TIMER)	66
Calibration Lock Feature	67
13. Data Logging	68
AutoLog Feature	68
Grouping Measurements	69
Measurement Screen while Data Logging.....	69
Starting a Data Logging Session (START LOGGING)	70
Ending a Data Logging Session (STOP LOGGING)	70
Starting a new Group of Measurements (START NEW GROUP)	71
Deleting the Last Measurement (DELETE LAST)	71
Clearing the Data Logger Memory (CLEAR MEMORY)	72
Viewing the Data Logging Status (DATA LOGGER STATUS).....	73
Setting the AutoLog RELEASE period (DLOG RELEASE TIME)	73
14. HelmetView Remote Display	74
Fitting the Mounting Bracket.....	74
15. Topside Repeater Remote Display Kit	76
Part Numbers.....	76
Kit Contents.....	76
Operation	77
Turning the Unit On.....	77
Turning the Unit Off	77
Changing the Displayed Units	77
Display Hold Function	77
Automatic Display Backlight.....	77
Connecting to the DIVE Gauge	77
Testing the Link.....	78
Changing the Batteries	78

Topside Repeater with Video Overlay	78
Connecting the Video Signal	79
Positioning the On-Screen Display	79
16. CygLink Surface Display and Control Kit	81
Part Numbers.....	81
Kit Contents.....	81
Connection Diagram.....	82
Connector Details and Signals	82
Using CygLink with HelmetView	82
Installing CygLink	83
Requirements.....	83
Upgrading.....	83
Installing	83
COM Port Numbers	84
Setting the COM Port Manually	84
Finding your COM Port Number	84
Connecting to the Gauge	85
First time USB Connection.....	85
Connecting the Gauge to CygLink for the First Time	86
Connecting to the Gauge Afterwards.....	87
Disconnecting from the Gauge	88
Manual Connection Settings.....	88
Changing Gauge Settings.....	89
Material Velocity List	89
A-Scan Measurement Cursors.....	90
Using the A-Scan Cursors with Twin Crystal Probes	90
CygLink Surveys and Data Logging.....	91
Editing the Survey Details	92
Editing the Survey Group Details.....	93
Producing a Survey Report Document	93
Transferring Data Logged Measurements from the DIVE gauge... ..	94
Logging Measurements Directly in CygLink	95
Reference and Minimum Thickness Criteria	95
Pre-Set Measurement Comments List.....	95
Adding Comments or Notes to a Measurement	96
To Change the COM Port number assigned by Windows®	97
Opening Device Manager.....	97
CygLink Trouble Shooting	98
Connection Problems – USB Drivers	98
Wiring Problems	99

17. General Points on Thickness Gauging using Multiple Echo Measurements.....	100
18. Care and Servicing	101
Cleaning the Gauge.....	101
Batteries	101
Environmental.....	101
Repairs	102
Returning the Gauge for Servicing.....	102
19. Replaceable Parts	103
Wrist Strap.....	103
Push Buttons	103
20. Spares and Accessories List.....	104
Ultrasonic Probes.....	104
Probe Spares for S*C 13mm (1/2") Probes	104
Probe Spares for S*A 6mm (1/4") Probes.....	104
Gauge Spares	105
Accessories.....	105
Miscellaneous Spares	106
21. Technical Specifications.....	107
22. Table of Sound Velocities.....	110
Reading Conversions	111
23. Recycling and Disposal (EC Countries).....	112
24. Shipping of Lithium-Ion Batteries.....	113
Battery Information	113
25. Warranty Information.....	114
26. Pressure Test Statement.....	115
27. Connection Diagram: Umbilical Cable	116
28. Connection Diagram: Umbilical to TSR.....	117
29. Connection Diagram: DIVE to Umbilical	118
30. Index	119

1. Introduction

Cygnus DIVE Underwater Thickness Gauge

The Cygnus DIVE Underwater Thickness Gauge has been specifically designed for the professional diver undertaking metal thickness surveys in both shallow and deep water sites. It has been design to withstand the extreme environments encountered while providing quick, clear and accurate metal thickness measurements using the Cygnus Multiple Echo technique and Single Echo / Echo-Echo options.

The Cygnus DIVE Underwater Thickness gauge is pressure rated to a maximum depth of 300 meters sea water (984 ft).

The gauge can be worn on the diver's fore-arm allowing one hand to remain free while carrying out the thickness survey. A bright colour display shows the thickness measurement in large numbers. Thickness measurements are further backed up by an A-scan display. Measurement data can be sent to the surface via a RS-485 serial data link where they can be data logged and used to produce a survey report using Cygnus' CygLink software.

Measurements can be displayed in Metric (mm) or Imperial (inch) units and measurement resolution can be selected from 0.01¹, 0.05 or 0.1 mm, (0.001², 0.002 or 0.005 inch). Thickness measurements can easily be calibrated to a known thickness or to a known Velocity of Sound.



The gauge is a solid-state electronic instrument which, under normal operating conditions, will give many years of active service.

Although designed for ease of operation first time users should carefully read this manual to familiarise themselves with the features of the gauge

¹ Single Echo Mode Only

² Single Echo Mode Only

Cygnus Instruments

Cygnus Instruments Limited, founded in 1983, pioneered the development of the Digital *Ultrasonic Multiple-Echo Technique* used for measurement through coatings. This has long since been the standard required to ensure that accurate measurements are taken without the need to zero the gauge or remove any coatings first.

Our philosophy is to work closely our customers to provide high quality products, engineered to serve heavy industry & harsh environments. Cygnus Ultrasonic thickness gauges are designed to be reliable and simple to use. We have an unrivalled reputation in over 45 countries around the world.

Contact Details

CYGNUS Instruments Ltd.

Cygnus House, 30 Prince of Wales Road,
Dorchester, Dorset, DT1 1PW England.

Website: www.cygnus-instruments.com

Tel: 00 44 (0) 1305 265533

sales@cygnus-instruments.com

For all Cygnus offices and Authorised Cygnus Service Centres and Distributors around the world please refer to the Cygnus website Worldwide Distribution page.

<https://cygnus-instruments.com/about-us/worldwide-distributors/>



Gauge Kit Contents

The DIVE gauge is supplied as a complete kit in a tough Peli® transportation case. Everything you need to begin taking thickness measurements is included in the kit.

1. Cygnus DIVE Gauge Body and Wrist Strap
2. Ultrasonic Probe(s) with Coiled Cable
3. Two Rechargeable Batteries
4. Membrane Couplant, 25ml bottle
5. Battery Charger and Charger Base
6. AC Mains Lead for Battery Charger
7. Ultrasonic Couplant Gel (Blue), 100ml bottle
8. Test Block 15mm (or ½") thick in Mild Steel
9. Spare Probe Membranes
10. Membrane Key
11. Silicone Grease, 50g tube
12. USB Flash Drive with Documentation³
13. Calibration Certificate
14. Operating Manual



³ With Data Logging Option and software

2. The DIVE Gauge

Features of the DIVE Gauge



<p>Left Side View showing Button, Battery & Probe Connector with Cap Fitted</p>	
<p>Right Side View showing Button, Battery Retaining Screw & Probe Connector</p>	

Fitting the DIVE Gauge

The DIVE gauge can be worn on the fore-arm of the diver allowing one hand to remain free during thickness surveys. The gauge is secured with a tough elasticated strap with a quick release buckle, the strap can be tightened easily using one hand and being elasticated it will maintain its grip on the diver's dry suit.

The Ultrasonic Probe is attached with a coiled cable allowing the diver to reach around structures when carrying out the survey. When not in use the probe can be easily secured to the strap by a loop and toggle using one hand.



Probe Securing Loop

The DIVE gauge can be worn on the right or left arm of the diver as required. The probe can be connected into either of the two probe sockets on the gauge body, they are both identically wired. The other free connector can be used for the top-side RS-485 data link, when not used a blanking plug is supplied to protect the connector.



Right and Left Handed Probe Connections



A security lanyard is supplied that can be attached to the D ring on the DIVE gauge then secured to a ring on the diver's harness.



Security Lanyard fitted to D ring.

3. Batteries

Important Notes

-  The battery **MUST** be fitted **BEFORE** the DIVE gauge is immersed into water.
-  The battery **MUST** be removed when the DIVE gauge is no longer being used and/or stored in its Peli case.
-  The battery **MUST NOT** be removed while the DIVE gauge is underwater.

Use in Hyperbaric Conditions

-  The battery contains lithium and therefore **MUST NOT** be taken into a Hyperbaric Condition (IMCA D 041)

Shipping of Lithium Batteries

Please see Section 24 Shipping of Lithium-Ion Batteries on page 113

Fitting the Battery

Smear some Silicone Grease on the face of the battery. This will help lubricate and seal battery contacts and screw threads.



Align the battery and push fully into the battery compartment in the side of the DIVE gauge body. There is a locating feature that ensures the battery is correctly aligned before the electrical contacts mate.

The gauge will then turn on.



The battery is secured with the battery retaining screw on the other end of the DIVE gauge body.

Turn the battery retaining screw clockwise to engage the screw into the battery.



Finger-tight only – *the should be no gaps between the battery screw and the body.*

 DO NOT use a tool to tighten



Removing the Battery

The battery must be removed after used and when stored in the carry case.

Unscrew the battery retaining screw and give a gentle push to push the battery out of the DIVE gauge body.

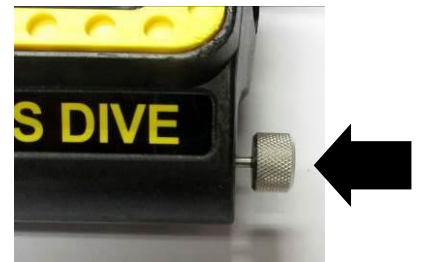

Charging the Battery

<p>The battery must be charged using the supplied Cygnus battery charger and base.</p>	
<p>The battery is inserted into the charger base taking care to align the two battery contacts.</p> <p>The light on the black charging unit will light as follows:</p> <p>Red = Fast Charge Green = Charge Completed</p>	
<p>The charge time for a flat battery is around 2.5 hours to 100% capacity at 25°C.</p>	<p>2½ Hours</p>

4. Fitting the Ultrasonic Probe

Important – Cap Fitment



The Cap must be fitted to the socket when it is not being used. Do not use the gauge with this socket exposed to water.

Accidental removal of the Cap while underwater WILL NOT cause the gauge to flood. Simply re-fit the Cap as soon as possible.

Packing silicone grease in the connections of the unused connector will prevent damage if Cap accidentally removed.





Probe Socket Cap Correctly Fitted.

Connecting the Probe

The Ultrasonic Probes have a coiled underwater cable and latching connector.

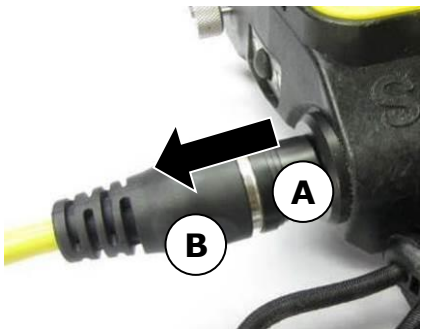

<p>The probe connector can be plugged into <u>either</u> of the connectors on the DIVE gauge body depending on which arm the DIVE gauge is worn on.</p>	
<p>The connector is a simple push-fit. The white dots must be aligned for the connectors to mate.</p>	
<p>To release the probe connector you must pull back the connector front part of the body (A) as you pull the connector out of the gauge body.</p> <p>If the connector appears tight push the back part (B) in towards the gauge while pulling back on the front part (A).</p>	

Probe Calibration Check Message

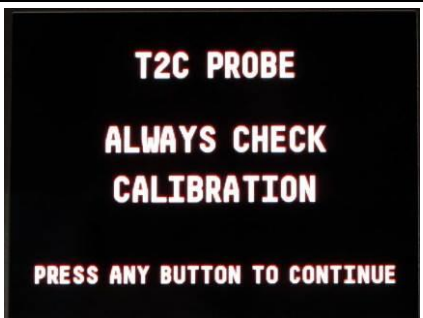
<p>If you connect a probe while the gauge is turned on a message reminding you to check the calibration will be displayed.</p> <p>Press either button to continue.</p>	
--	---

Securing the Probe while Diving

You can secure the probe to the wrist strap using the loop and toggle, the probe can be secured and released with one hand.

To secure the probe (if not already) press the toggle and push it back towards the gauge body to make the loop large. The probe can then be tucked under the loop and the toggle pressed and pulled with finger and thumb towards the probe to secure it.



To release the probe, press the toggle with finger and thumb and push back towards the gauge body. The probe can then be un-tucked from the loop.

5. Ultrasonic Probes (Transducers)

Important Notes



The gauge should only be used with ultrasonic probes supplied by Cygnus Instruments.

Probe Types

There are two types of probe that can be supplied with the DIVE gauge; **Single and Twin Element**.

Typically marine surveyors have used **single element** probes with multiple echo measurement which gives reliable measurement even through coatings.

Typically the general NDT industry has used **twin element** probes with single and echo-echo measurement which can offer better detection of corrosion defects but require more awareness and training to avoid measurement errors.

Ideally a surveyor's kit would contain one of each probe type enabling any survey to be tackled with the confidence you'll be able to get reliable measurements whatever the condition of the metal.

For more information see Measure Modes on page 29.

Single Element Probes

Cygnus pioneered the use of single element transducers and the multiple echo technique. **Multiple Echo** measurement offers the most reliable and accurate type of thickness measurement through coatings.

However there are situations when getting a measurement with a single element probe using Multiple Echo is difficult or impossible – in these situations the **twin element** probe will allow thickness measurements to continue to be taken.

Twin Element Probes

Twin Element probes can be used to take thickness measurements on both **Coated** and **Un-Coated** metals.

When measuring on Uncoated surfaces **Single Echo** mode can be used. Single Echo mode will also work best when measuring Heavy Corrosion – heavy corrosion will absorb and scatter the ultrasound signal so there is often only enough ultrasound reflected back to the probe to provide a single echo.

Identifying Single or Twin Element Probes

You can easily identify each type of probe by looking at the probe face;

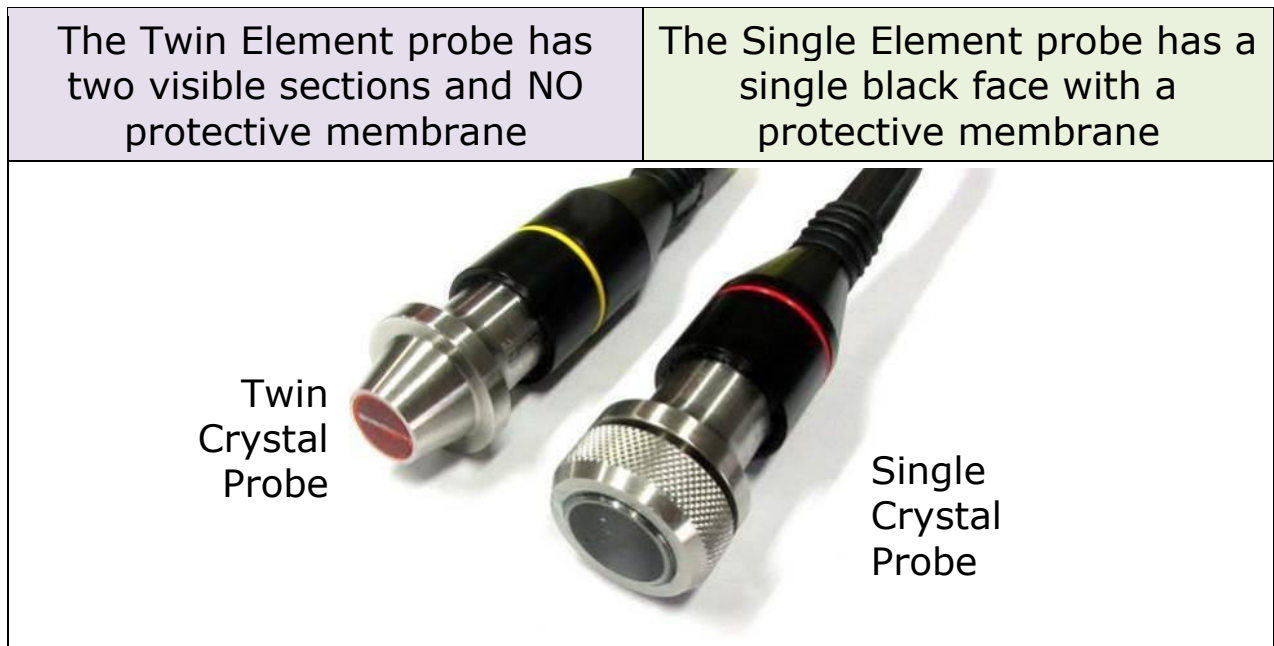

Probe Identification Band

Each probe also has a coloured band fitted to help identify the probe type and frequency.

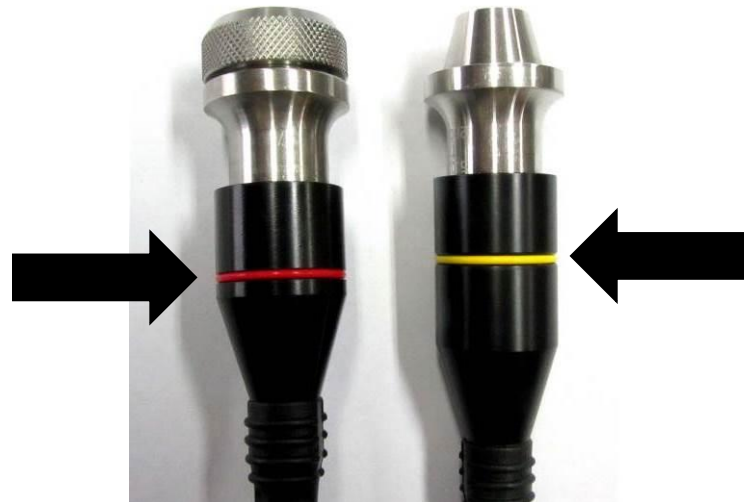

Probe Identification Bands

Probe Frequencies

As well as the two different probe types there are different frequencies available in each probe type. These different probe frequencies allow measurement of different materials

Twin Element Probes			
Probe Type	Details	Applications	Identification
T5B	5 MHz 2 x 8 mm (0.5")	A twin element probe suitable for most applications, including heavily corroded and pitted steels.	Yellow Band
T2C	2.0 MHz 2 x 13 mm (0.5")	Cast Irons Plastics	Blue Band
Single Element Probes			
Probe Type	Details	Applications	Identification

Twin Element Probes			
Probe Type	Details	Applications	Identification
S2C	2.25 MHz 13 mm (0.5")	A single element probe suitable for most applications.	Red Band
S3C	3.5 MHz 13 mm (0.5")	Suitable for measurement on thinner sections where surfaces are relatively rough	Orange Band
S5C	5.0 MHz 13 mm (0.5")	Ideal for thin sections without heavy corrosion.	Black Band
S5A	5.0 MHz 6 mm (0.5")	The higher frequency and narrower beam makes this Probe ideal for measuring small-bore tubing, thin section plate and other areas where access is limited.	Black Band

Lower frequency probes offer better penetration on heavy corrosion/coatings.

Probe Measurement Ranges

Each probe type has a defined measurement range to be aware of.

Probe Type	Measurement Range (in steel)	
T5B	2.0 – 100 mm (SE) 4.0 – 50 mm (EE)	0.08 – 4 inch (SE) 0.16 – 2 inch (EE)
T2C	3.0 – 150 mm (SE) 6.0 – 50 mm (EE)	0.12 – 6 inch (SE) 0.24 – 2 inch (EE)
S2C	3.0 – 250 mm ⁴	0.12 – 10 inch

⁴ To measure thicknesses on tall thin cylinders or columns the height-width ratio should be no less than 1.0:0.6 (Height:Width) otherwise side reflections prevent measurement.

Probe Type	Measurement Range (in steel)	
S3C	2.0 – 150 mm	0.08 – 6 inch
S5C	1.0 – 50 mm	0.04 – 2 inch
S5A	1.0 – 50 mm	0.04 – 2 inch

The three letter Probe Type code can be easily decoded;

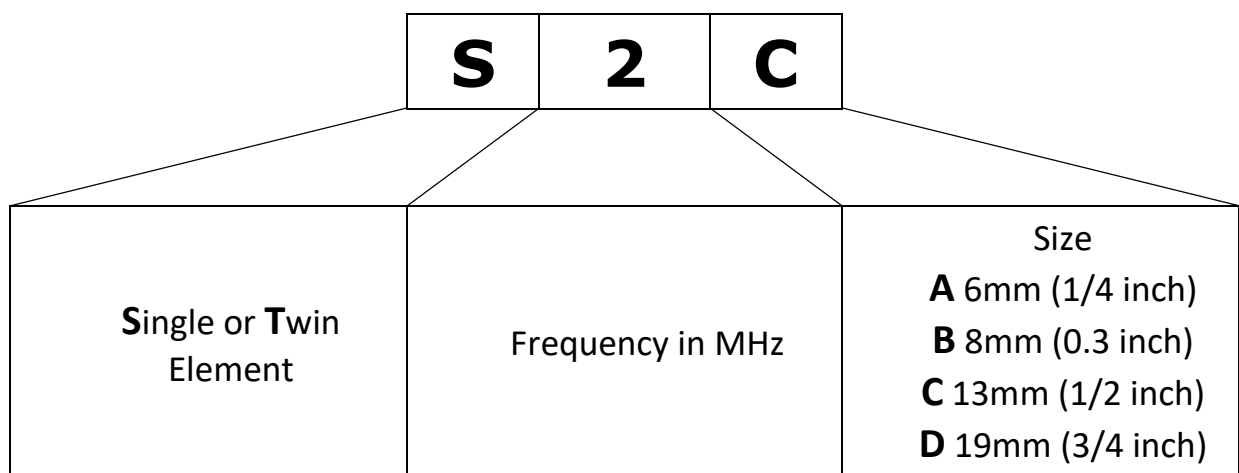

Probe Selection Chart

Use this chart as a guide to selecting the right probe for your application.

No	Application	Probe Type					
		S2C	S3C	S5C	S5A	T5B	T2C
1	Painted, coated & bare metals. Coatings up to 20mm (3/4in) thick ² . Corrosion: non to moderate. Thickness: 3 to 250mm (1/8in to 10in) ¹ . Class Shipping Surveys. General purpose use.	✓					
2	Painted & bare metals. Corrosion: non to moderate. Thickness: 2 to 150mm (0.1in to 6in) ¹ .		✓				
3	Painted & bare metals. Corrosion: non to light. Thickness: 1 to 50mm (0.05in to 2in) ¹ .			✓			
4	Small diameter pipes. Boiler tubes. Corrosion: non to light. Thickness: 1 to 25mm (0.05in to 1in) ¹ .				✓		
5	Uncoated or coated metals ³ . Corrosion: very heavy, pitting. Thickness: 2.0 to 100mm (0.08in to 2in) ¹ . General purpose use.					✓	
6	Uncoated or coated metals ³ ; Cast Iron. Wrought Iron. Plastics. Corrosion: very heavy, pitting. Thickness: 3.0 to 150mm (0.12in to 6in) ¹ .						✓

Notes.

1. Thicknesses stated are for steel with a velocity of 5920 m/s (0.2331 in/ μ s), this will vary with different metals/materials.
2. S2C Probe using Deep Coat mode to measure through thick coatings.
3. T5B & T2C Probes will include any coating thickness in the metal thickness measurement when used in Single Echo mode.

Single Element Probes and Protective Membranes

All Cygnus single element probes have a soft face and are therefore fitted with a Polyurethane Membrane which provides better contact on rough surfaces and protects the probe face from wear, prolonging the life of the probe.

Check the membrane regularly as it is important the membrane is changed as soon as it shows any signs of wear.

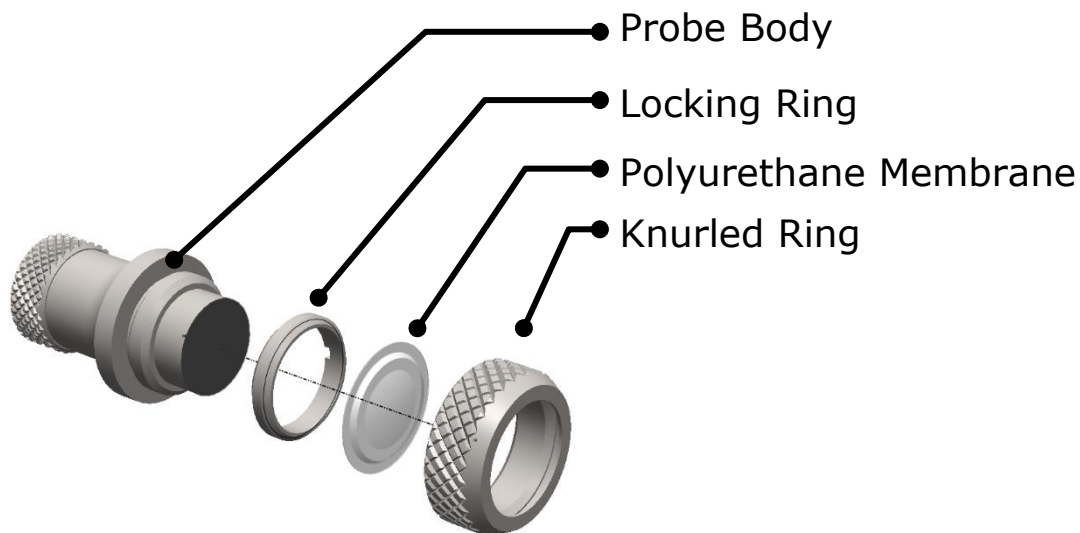



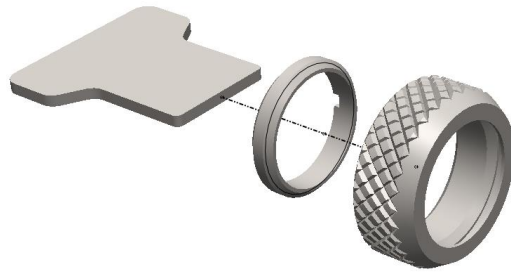

Single Element Probe Membrane Parts.

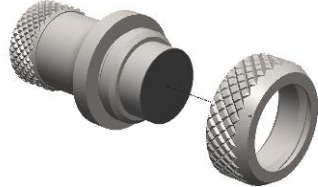
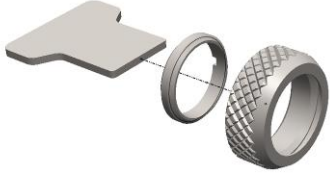
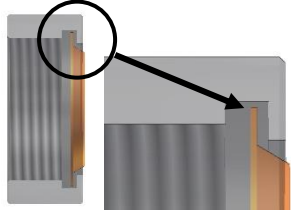
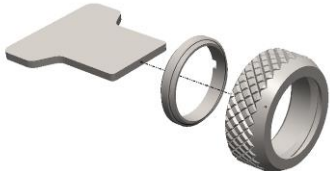

Single Element Probe Membrane Locking Key

Changing the Protective Membrane on Single Element Probes

<p>1.</p>	<p>Unscrew the Knurled Ring from the end of the Probe.</p>	
<p>2.</p>	<p>Use the Membrane Key to unscrew the Locking Ring from inside the Knurled Ring. The old membrane can then be removed and discarded.</p>	
<p>3.</p>	<p>Place a new membrane into the end of the Knurled Ring ensuring it locates in the groove.</p>	
<p>4.</p>	<p>Screw the Locking Ring back inside the Knurled Ring and tighten with the Membrane Key.</p>	
<p>5.</p>	<p>Place a few drops of Membrane Couplant on to the probe face.</p>	
<p>6.</p>	<p>Screw the Knurled Ring back onto the probe. Use your thumb to squeeze the couplant from under the membrane as you tighten the Knurled Ring down.</p>	
<p>7.</p>	<p>You should see the membrane has a very thin film of couplant between itself and the probe face with <u>no air bubbles</u>.</p>	

Automatic Probe Type Detection

The DIVE gauge can automatically determine the probe type when it is first connected to the gauge setting the appropriate parameters to suit the Probe Type. This feature will operate when the probe type is set to AUTO⁵. To set the probe type see Probe Type Selection on page 66.

Twin Element Probe Wear Indication

The twin element probes have a hard-face that under normal use should last a long time. However this hard face will gradually wear down due to the abrasive action of measuring corroded metals.

When the probes hard face has worn down by 2mm (0.08in) or more the gauge will detect this and display a PROBE WORN message to the user, the gauge will then not be able to use this probe for measurements and a new probe must be used.



Probe Worn Message.



Probe Worn Message on Measurement Screen.

⁵ AUTO will only detect S2C, T5B & T2C Probe Types. Other frequencies have to be manually set.

6. Measure Modes

The Measure Mode determines how the gauge uses the ultrasound signals to get a thickness measurement. There are three measurement modes used in the DIVE gauge;

- **Multiple Echo Mode - Single Element Probes Only**
- **Single Echo Mode - Twin Element Probes Only**
- **Echo-Echo Mode - Twin Element Probes Only**

The gauge will automatically set the measure mode to match the probe type selected.

Multiple Echo Mode (ME)

Multiple Echo measurement mode is by far the most reliable and quickest method for thickness measurements because it works by looking for three matched echoes it can **verify** the thickness measurement is valid. This method has been used in all Cygnus gauges since the late 1970s.

Multiple echo mode will ignore surface coatings (Through Coating mode) there is no need to remove the paint to take a measurement.

Also because it uses a single element (or single crystal) probe there are no errors due to the V-path of the ultrasound beam found in all twin element probes. This makes it simple to calibrate – two point calibrations are not required.

However because it requires three echoes to take a measurement, in heavily corroded steels there is often an insufficient number of echoes so measurements may not be possible.

Single Echo Mode (SE)

Single Echo measurement mode is most useful on heavily corroded metals where Multiple Echo fails. Because it only needs the first return echo to take a measurement it performs well on virtually all steel conditions.

However single echo mode will not ignore any surface coatings, so if you measure through a coating it will give an incorrect metal thickness measurement. If the surface coating is very thin (0.2mm / 0.01") paint you can make an allowance for this error, but thicker coatings introduce too much error to be practical.

Single echo measurements use a twin element (twin crystal) probe, because there are two elements angled to a focal point there is a v-path error introduced. However this v-path error is mostly corrected by the gauge, and furthermore by performing a two point calibration.

Twin element probes require "zeroing" at regular intervals, especially if the ambient temperature is changing.

To overcome some of the drawbacks of Single Echo measurements the gauge has an A-Scan display that can be used to visually verify the thickness measurements are sensible and therefore reliable.

Echo-Echo Mode (EE)

Echo-Echo mode uses a twin element probe, but measures between the first two echoes. This method is intended to ignore any thin surface coatings whilst still using a twin element probe.

Echo-Echo mode is not able to verify its measurements unlike Multiple Echo mode, therefore it is possible to give incorrect readings. But as the DIVE gauge has an A-Scan display you can use this to visually decide if the measurement given is correct.

Echo-echo mode must therefore be used with caution, and only on thin paint surface coatings (less than 0.5mm/0.02"). It is recommended a Single Echo measurement should also be made to help verify the measurement makes sense (the Single Echo measurement should always be slightly thicker due to the coating thickness).

The DIVE gauge will perform a basic verification check on any Echo-Echo signal before it calculates thickness. If the position of

the 2nd echo is not within the expected region for a 2nd echo then it is ignored and not used to give a thickness measurement. This check will help ensure Echo-Echo measurements are correct and discard any impractical measurements.

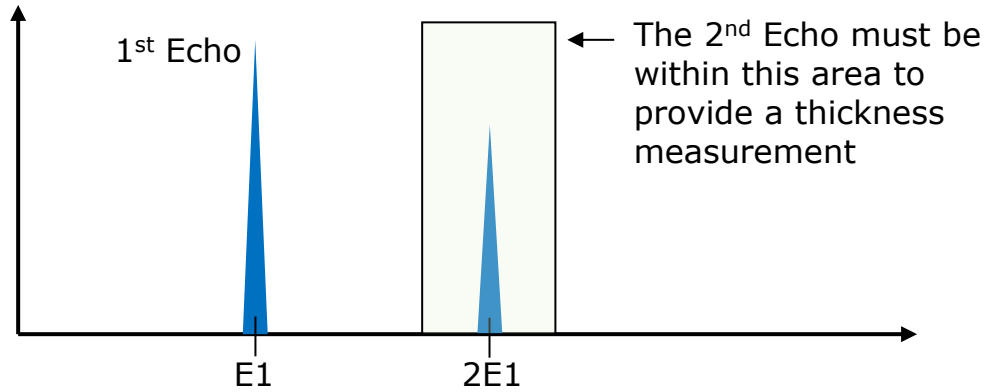

Measuring Small Diameter Pipe & Tubes

When measuring small diameter pipe and tubes with a twin element probe, 75mm (3”) or under, you must ensure the face of the probe is correctly aligned to the curvature of the pipe otherwise measurements may be inaccurate.

! The dividing line on the face of the probe should be at right angles to the length of the pipe.

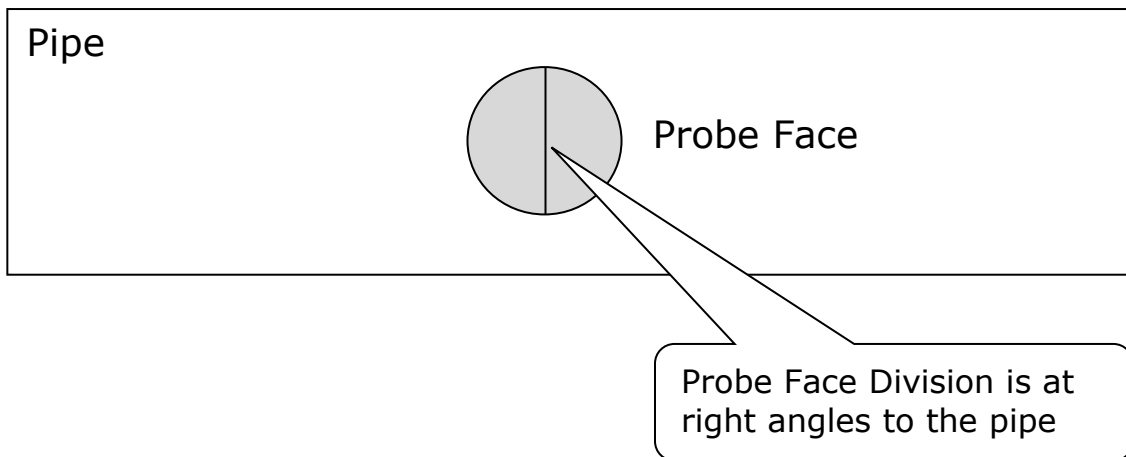

7. Why should I Calibrate my Thickness Gauge?

Ultrasonic thickness gauges measure time in order to measure the thickness of the material being tested. They rely on the principle that sound travels through a material at a constant velocity or speed. If you can accurately measure the time it takes to travel through a material and you know its velocity then you can calculate its thickness;

$$\text{Thickness } d = \frac{\text{time} \times \text{velocity}}{2}$$

Modern thickness gauges are easily capable of measuring **time** accurately to 10 nano seconds (0.000,000,01 seconds) so this is considered to be more than sufficiently accurate.

This means the accuracy of any thickness gauge measurement relies principally on the **velocity** being correct for the material being measured.

There are tables listing the velocity of most common metals and materials, but these velocities are only "typical" values. For example Mild Steel has a typical velocity of 5920 m/s – but in practice when measuring a variety of mild steel samples the velocity can range anywhere from 5860 to 5980 m/s.



This means if you want to achieve the most accurate thickness measurements you must calibrate your thickness gauge to a sample of the same material you will be testing – and a sample that you can accurately measure its thickness with a Vernier or Micrometer.

Your measurements are only as good as your calibration



Instructions on calibrating the DIVE gauge can be found on pages Setting the Velocity of Sound (VELOCITY) 57 to 59.

8. Using the DIVE Gauge

Turning the Gauge On

<p>Fitting a battery to the DIVE gauge will turn on the gauge.</p> <p>The gauge will display the Cygnus logo screen while it starts up.</p>	
<p>If the DIVE gauge has gone into standby mode then press and hold either button until the gauge turns on (<i>this may take up to 5 seconds</i>).</p> <p><i>Note. Turning the gauge back on from standby will skip the following two steps.</i></p>	
<p>The next screen displays the Serial Number, Software Version and Run Time.</p> <p><i>You can freeze the screen by pressing any button, press again to unfreeze and continue.</i></p> <p>Your attention is drawn to the warranty statement.</p>	
<p>The next screen displays a red warning message reminding you to remove the battery after use and to re-calibrate before use.</p> <p>Press either button to continue.</p>	

Zeroing the Probe (twin crystal)

<p>If there is a twin crystal probe connected to the gauge you will be asked to perform a probe zero when the gauge is first turned on.</p>	 <p>Probe Zero Screen</p>
<p>Simply wipe the probe face clean of any couplant and press either button to continue – the gauge will then perform a probe zero and wear check.</p> <p>If the probe is worn out a message will be displayed. See Twin Element Probe Wear Indication on page 28.</p>	 <p>Probe Zero Done</p>

Turning the Gauge Off

While there is a battery fitted the gauge goes into a Standby mode to save power. The battery will last for up to 3 weeks in standby mode but it is recommended to remove the battery after the end of each dive.

The gauge will automatically go into standby mode after a period of inactivity to save battery power.

<p>To manually put the DIVE gauge into Standby mode from the main measurement screen press and hold the Right Button until the message "Standby Mode" is seen.</p>	
--	---

Before Each Dive

It is recommended you test the operation and calibration of the DIVE gauge before each dive. Follow these steps to ensure the equipment is functioning correctly:

- 1. Generously smear silicone grease on the face of the battery**
- 2. Fit the battery to turn the gauge on**
- 3. Check you are using a charged battery – check the battery level indicator**
- 4. Check the probe membrane is in good condition and there are NO air bubbles between the membrane and probe face**
- 5. Plug in the probe connector and check the gauge identifies the probe correctly**
- 6. If required Zero the probe as instructed**
- 7. Ensure the cap is fitted to the spare connector**
- 8. Test gauge operation by measuring the Test Block included in the kit (use a drop of couplant gel)**
- 9. Check the calibration is correct for the material you will be measuring, ideally measuring a known thickness of the material (For mild steel set the 'default' velocity to 5920 m/s)**
- 10. If you are using a top-side link check its operation**
- 11. Visually check the condition of the strap**

The Measurement Screen

When the gauge is operating the measurement screen is displayed.

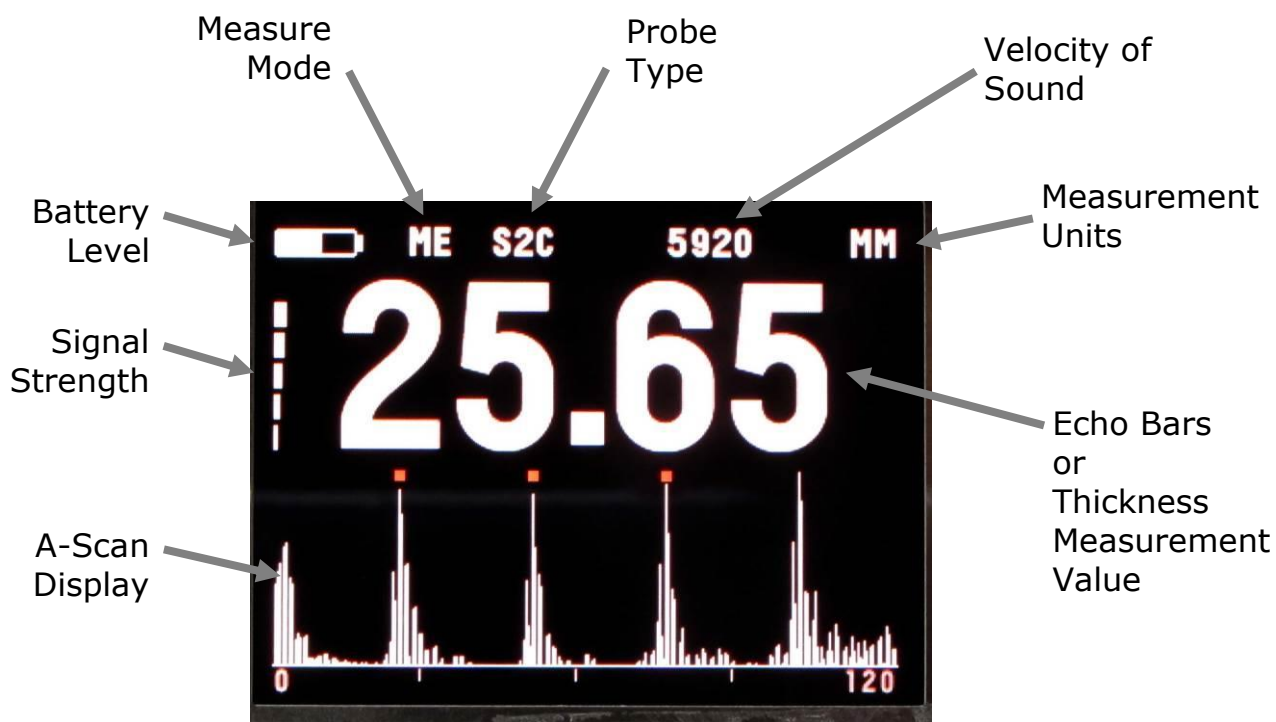

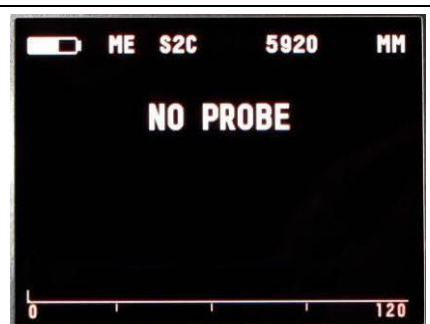

No Probe Connected Message

When the probe is disconnected from the gauge a NO PROBE message is displayed.

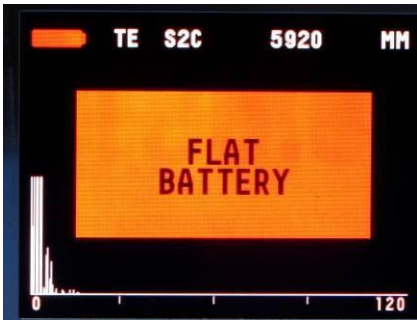

Low Battery Level

<p>When the battery level is getting low the Battery Level indicator first turns Orange in colour.</p>	
<p>When the battery has less than 30 minutes life the Battery Level indicator turns Red and a Low Battery message is flashed at the top of the screen.</p>	
<p>When the battery is flat the gauge will be turned off automatically. A message will be briefly displayed as the gauge turns off.</p>	

Displaying Thickness Measurements

<p>When the gauge is taking thickness measurements the main screen will show the current thickness value in large numbers.</p>	
--	---

The A-Scan Display

<p>The A-Scan display at the bottom shows the ultrasonic echo pulses received by the gauge.</p>	
---	---

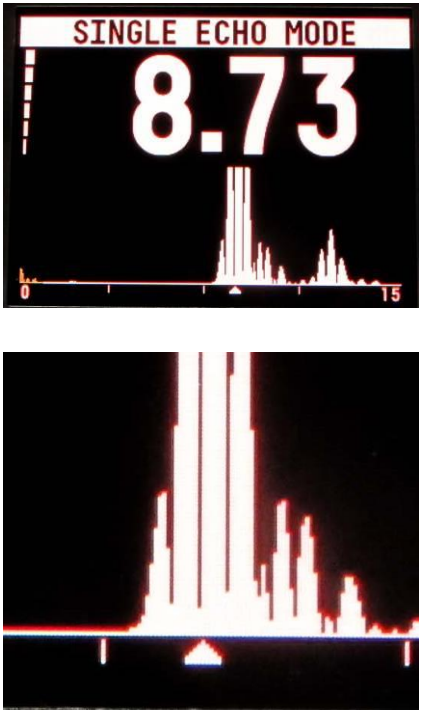
<p>When in Multiple Echo mode and a Multiple Echo verification has been found the three echo points are marked by three square boxes.</p>	
<p>When in Single Echo mode the echo point is marked by a single arrow below the X axis.</p>	

A-Scan Display in Single Echo Mode

In Single Echo mode the A-Scan display will always be displayed and cannot be turned off.

Surface Preparation

The DIVE gauge will not measure through barnacles or similar hard encrusters. You must therefore remove any hard marine growth before attempting a thickness measurement, typically divers use a scraper to do this.





Surface with barnacles removed

Thin layers of green algae over paint don't generally need to be removed.

When using Multiple Echo mode you **DO NOT** need to remove any paint or surface protection – the gauge is designed to read through and ignore these layers.

If there is loose rust (rusticles) or de-lamination of the metal surface then you will probably need to remove these loose outer layers with a scraping tool. Sometimes a chipping hammer is used to remove stubborn rust layers.

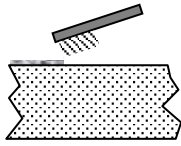
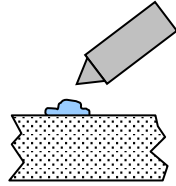
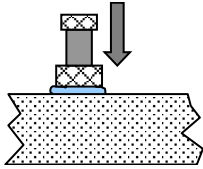
Taking a Thickness Measurement

Taking a Thickness Measurement		
1	Remove any marine growth, loose rust or loose coatings and brush the test area clean.	
2	When measuring underwater there is no need to use a couplant - the water itself will act as a couplant.	
3	When measuring in air apply some couplant gel to the test surface.	
4	Place the probe-face on the prepared test surface and make firm contact applying gentle pressure.	
5	The gauge will display a thickness measurement or an indication of Echo Strength if no valid measurement has been found.	

Measuring Small Pipe with Twin Crystal Probes

-  Twin Crystal probes must be orientated correctly when measuring pipes under 75mm (3") diameter, see Measuring Small Diameter Pipe & Tubes on page 31.

Signal Strength Indication

The vertical signal bars on the left side of the display show the relative strength of the received ultrasound signal - the more bars shown, the stronger the received signal.

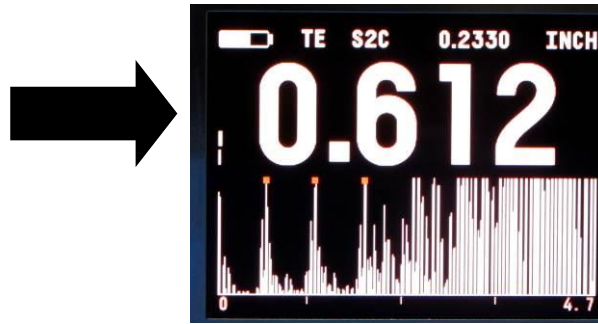

Echo Bars in Multiple Echo Mode

Should the gauge be unable to detect a stable Multiple Echo signal it displays an echo bar indication to help the operator locate a suitable position.

Multiple Echo Bars	
1 Bar Flashing: <i>No echoes detected</i>	
1 steady + 1 Bar Flashing: <i>Only 1 echo detected</i>	
2 steady + 1 Bar Flashing: <i>Only 2 echoes detected</i>	
3 steady + 1 Bar Flashing: <i>3 echoes detected but they are not matched</i>	

To help obtain a Multiple Echo reading the operator should continue to move the probe around using a slight rocking motion to locate a suitable reflector.

Note: When using the gauge underwater the ultrasound will travel through the water and can get reflected back to the gauge by

nearby surfaces, causing the echo bars to increase - this is normal.

Stability Indication in Single Echo & Echo-Echo Modes

To help indicate when a Single Echo or Echo-Echo measurement is stable – and thus probably reliable – the gauge changes the colour of the thickness measurement number from Red to Yellow when the measurement has been stable for 2 consecutive seconds.

When measuring using SE or EE mode once you have a measurement keep the probe still and wait for the gauge to signal a “stable reading”.

If the ultrasound signal is poor or erratic then the thickness value may remain Red – thus indicating the measurement may not be reliable.

When using the Data Logging feature – measurement will only be logged when the gauge has detected a stable reading.



Not Stable – RED



Stable - Yellow

9. Interpreting the A-Scan Display in Multiple Echo Mode

The A-Scan display shows the actual ultrasound echo pulses as seen by the gauge, these echo pulses are used by the gauge to determine the thickness measurement if possible.

In Multiple Echo mode the gauge works by generating a short pulse of ultrasound that is coupled into the object you are measuring. This pulse then travels through the object (both paint and metal) and is reflected back to the probe as an echo by either the back-wall of the object and/or any internal flaws or corrosion pits. This echo pulse will then continue to reflect back and forth inside the object until it finally runs out of energy. Each time the echo pulse hits the probe surface a signal is received by the DIVE gauge, this signal is shown on the A-scan display as an echo peak.

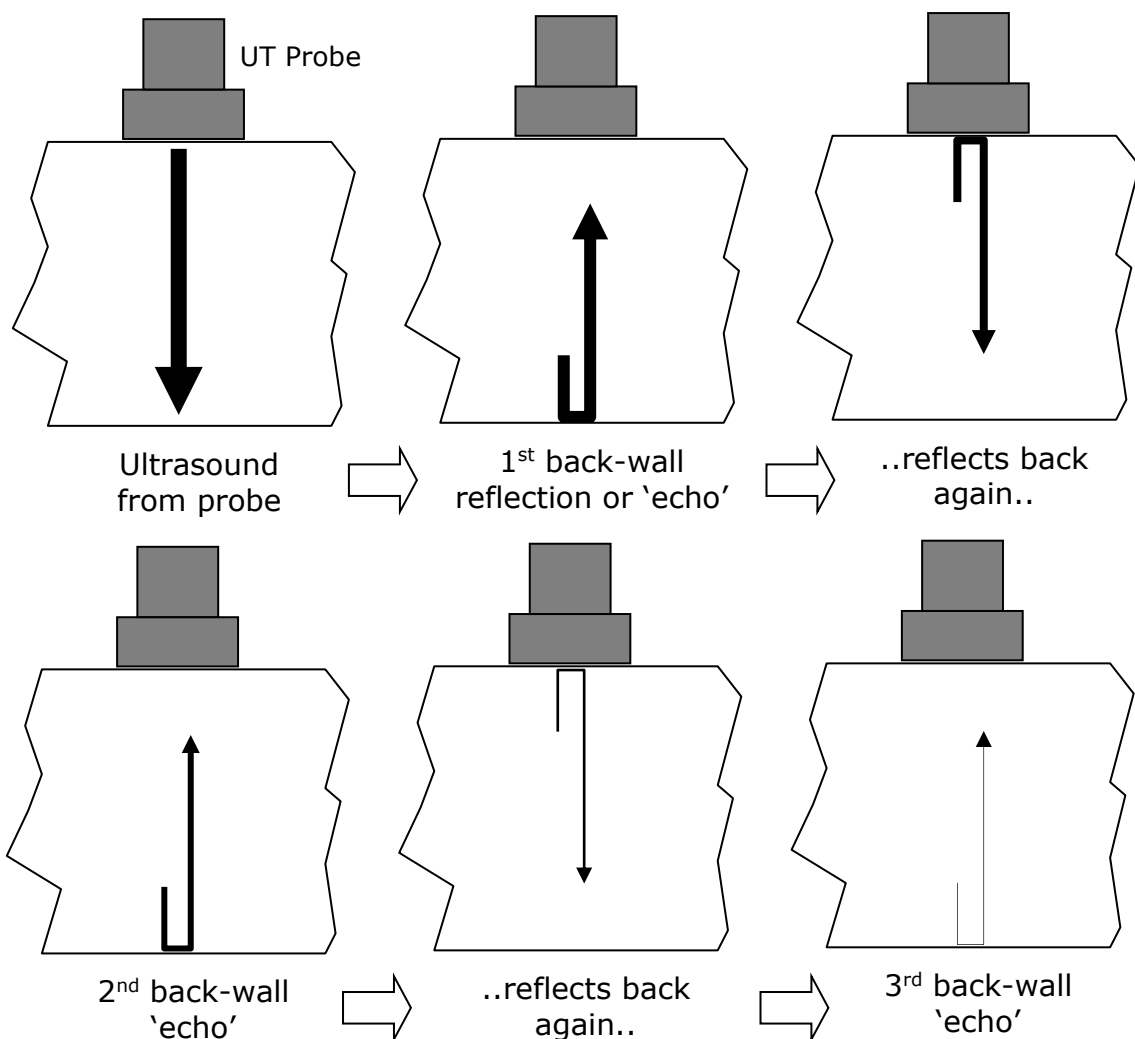

The DIVE gauge uses negative ultrasound pulses to measure thickness, so the A-scan display shows Half Wave Negative Rectified signals.

Pits and Flaws

To obtain a reliable Multiple Echo thickness measurement the gauge must be able to see three distinguishable equi-spaced return echo pulses. The A-scan below shows the echo pulses of ultrasound as measured in a flat, un-corroded, unpainted piece of steel 12.5mm thick:

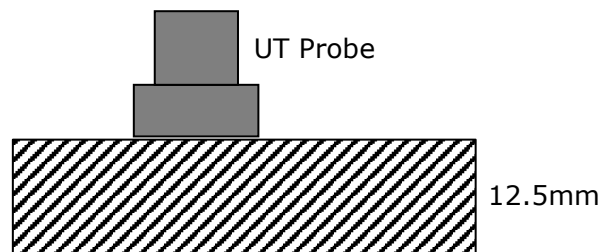

Flat, new steel 12.5mm thick.

You can easily identify the individual echo pulses and the gauge correctly measures the thickness and marks the echo pulses it used with three small squares (arrowed).

If we introduce a flat bottom hole into the steel, drilled half way through we can have a situation where the echo pulses from the hole are visible on the A-scan:

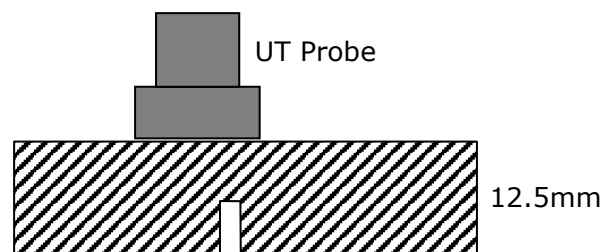

Flat, new steel 12.5mm thick with blind hole.

Now although the gauge is still correctly measuring 12.5mm you can see the echo pulses from the bottom of the blind hole (arrowed).

In practice if you see smaller peaks between the larger peaks it could be indication of pits or flaws inside the material you are measuring. By moving the probe around and observing the A-scan you may be able to identify an area with better, more distinct ultrasound echo pulses.

If the echo pulses from the pit or flaw obscure the pulses from the material back-wall the gauge may not be able to determine a Multiple Echo thickness measurement, the A-scan below shows a mixture of echo pulses that are spaced irregularly and as a result no thickness measurement has been located;

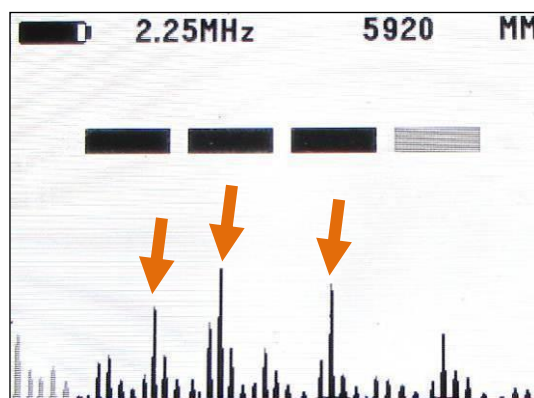

Uneven echo pulses from multiple uneven reflectors

Heavy Corrosion

Measuring on heavily corroded steel will cause the ultrasound echo pulses to scatter and be absorbed. The ultrasound will be reflected from multiple points as there is no one true metal thickness. This makes it difficult for the gauge to identify the three equi-spaced echo pulses. What you might see on the A-scan display is only one or two echo pulses as shown below:

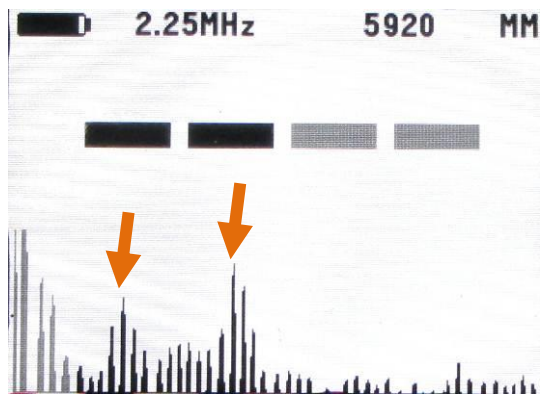

Heavily Corroded Steel Sample.

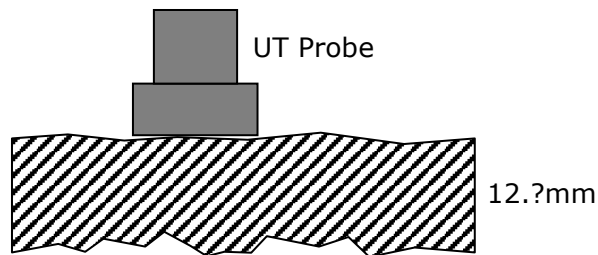

The best approach when having trouble getting Multiple Echo measurements is to try slowly moving the probe around the area looking for points where the echo pulses are stronger and more defined, keeping an eye on the A-scan so you spot “better” areas.



If you still are unable to get Multiple Echo measurements then you have the option of using a twin crystal probe and using the gauge in Single Echo mode.

10. Interpreting the A-Scan Display in Single Echo Mode

The A-Scan display shows the actual ultrasound echo pulses as seen by the gauge, these echo pulses are used by the gauge to determine the thickness measurement if possible.

In Single Echo mode the gauge works by generating a short pulse of ultrasound that is coupled into the object you are measuring. This pulse then travels through the object and is reflected back to the probe as an echo by either the back-wall of the object and/or any internal flaws or corrosion pits. When the echo pulse hits the probe surface a signal is received by the DIVE gauge, this signal is shown on the A-scan display as an echo peak.

The A-Scan display is very useful when measuring in Single Echo mode, as there is no Verification of the thickness measurement in Single Echo mode observing the A-Scan display will help the user verify the echo detected is the correct one – the back-wall echo.

<p>This A-Scan shows a good clear ultrasound signal.</p> <p>There is a well-defined back-wall echo and the arrow is correctly placed at the start.</p> <p>The measurement value of 14.6 is stable when yellow in colour.</p>	 <p>Good Signal</p>
<p>This A-Scan shows a very weak ultrasound signal.</p> <p>There is no clear correct back-wall echo.</p> <p>Although a measurement of 19.7 has been displayed its not stable and should not be relied on. The measurement value is red in colour when unstable.</p>	 <p>Poor Signal</p>

This is an A-scan from a T2C probe measuring cast iron.

This A-Scan shows a good clear ultrasound signal with a distinctive back-wall echo.

Even though there are small echoes before the back-wall peak, the arrow is correctly placed under the start of the biggest echo peak.

The measurement value of 39.2 is stable and yellow in colour.



Cast Iron

This A-Scan shows a very unclear ultrasound signal.

There are lots of echoes and it's not very clear which is the correct back-wall echo.

It is probably the biggest peak $\frac{3}{4}$ of the way across the A-scan graph – but the gauge may not detect this.

You can use the A-scan to check that the gauge has identified the correct peak which is marked by the arrow.

If it looks right and the arrow is in the correct position then you can decide to use the thickness measurement.

If it looks wrong then try another location.



Cluttered Signals



Measuring Over Corrosion Pits

-  You should be careful not to attempt to take a single echo thickness measurement when there is a void or corrosion pit directly underneath the probe face as the gauge may incorrectly measure the depth of the couplant.



Large Corrosion Pits.

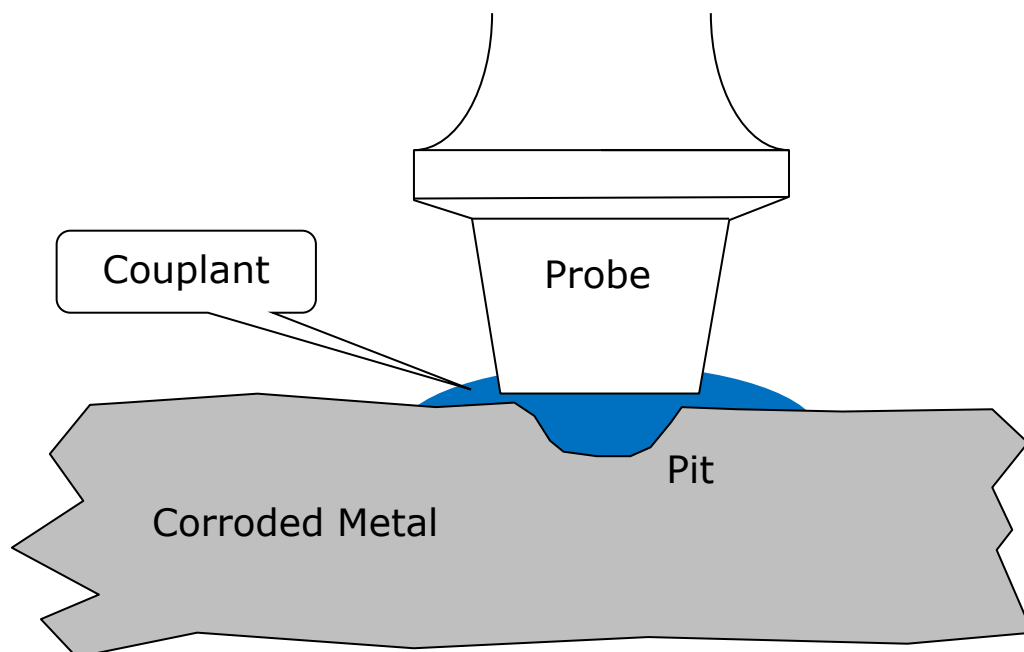

Avoid Measuring Directly Over Corrosion Pits.

The A-Scan display can assist you - you will see a unclear ultrasound signal with no distinct back-wall echo.

11. Interpreting the A-Scan Display in Echo-Echo Mode

Just like Single Echo mode when measuring using Echo-Echo mode the A-Scan display can provide valuable information on the quality and reliability of and thickness measurement, and when no thickness measurement is given it can help the user understand why not.

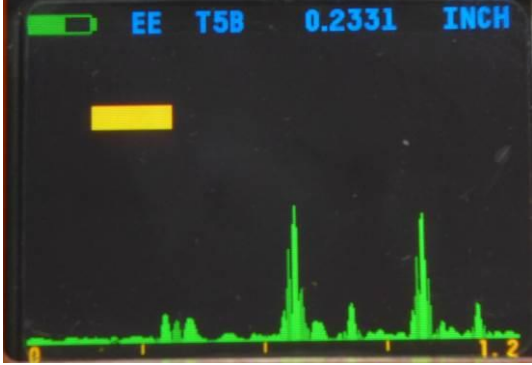
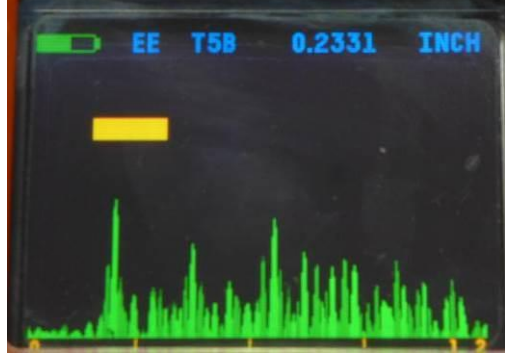
<p>Good Echo-Echo Signal.</p> <p>This A-Scan shows a clear 1st and 2nd echo and the gauge has correctly measured 12.1 mm.</p> <p>The echo-echo measurement is indicated by the solid Yellow which starts at the 1st echo and ends at the 2nd echo.</p>	
<p>No Measurement.</p> <p>The position of the 2nd echo is clearly less than 2 x 1st echo position – the gauge will not give a thickness measurement in this situation.</p> <p>Try moving to a different location or rotating the probe.</p>	
<p>Poor Signal – Noisy.</p> <p>The gauge has been unable to locate a suitable 1st and 2nd echo in the correct position. The signal is noisy (very corroded metal).</p> <p>Try moving to a different location or rotating the probe.</p>	

12. Changing Gauge Settings

The Two Button System

The DIVE gauge only has two buttons – this means there are only three combinations to remember;

- Left Button Press
- Right Button Press
- Both Buttons Pressed Together*

*Both Buttons being pressed is generally used to Save & Exit.

Button Functions in Menus

Menus are lists of items – you scroll down the list and select the item that is highlighted. If you don't press a button for 20 seconds the menu will automatically exit.



A menu screen

- | | |
|--------------|-----------------------------------|
| Left Button | : Scroll around the list of items |
| Right Button | : Select the highlighted item |
| Both Buttons | : Exit the menu |

Button Functions in Setup Screens

Setup screens let you change a setting or value. For example changing the units between mm and inches. If you don't press a button for 20 seconds the menu will automatically exit without saving any changes.



A setup screen – mm or inches

- Left Button : Decrease or change the value
Right Button : Increase or change the value
Both Buttons : Save and Exit the setup screen

Gauge Settings Saved with Probe Type

Certain gauge settings are saved against the probe type. This allows each probe type to have different settings that will be recalled when that probe is re-connected and the probe type is correctly set. The following settings are saved with each probe type;

- Units
- Resolution
- Velocity
- Calibration
- Deep Coat (if single crystal probe – multiple echo mode)

Displaying the Menu

To display the main Menu press the Left Button once.



Measurement Screen

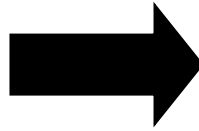

Main Menu Screen

Pressing the Left Button again will scroll down the Menu List one step each press.

Pressing the Right Button will open the selected Item.

Menu Tree Diagram

The menu tree diagram shows the gauge’s menu items in the order they are displayed. Note some of the items are only displayed if that feature is enabled.

Measurement Screen

Displayed when;

Main Menu

DATA LOG MENU

START LOGGING

CLEAR MEMORY

DATA LOGGER STATUS



Data Logging Stopped

DELETE LAST

STOP LOGGING

START NEW GROUP

CLEAR MEMORY

DATA LOGGER STATUS



Data Logging Started

DEEP COAT

Multiple Echo Mode

MEASURE MODE

SE/EE Mode

A-SCAN RANGE

A-SCAN DISPLAY

Multiple Echo Mode

VELOCITY

Not Measuring

CALIBRATE Or

Measuring

CALIBRATE 2 POINT

SE/EE Mode

MATERIAL LIST

ZERO PROBE

SE/EE Mode

UNITS

RESOLUTION

PROBE TYPE

SETUP MENU

POWER-SAVE TIMER

DLOG RELEASE TIME

Data Logging Menu (DATA LOG MENU)

For the DATA LOG MENU items refer to the section on Data Logging starting on page 68.

A-Scan Range Setting (A-SCAN RANGE)

The X-axis of the A-scan graph is ideally set to show the best number of return echoes in the material being measured. The gauge can automatically adjust the A-scan range using the thickness measurement, or you can manually set the range to suit the material thickness you expect to measure.

You can choose from the following A-Scan range values;

- AUTO The gauge automatically adjusts the A-scan range
- 15 mm (0.6") Measuring material up to 15 mm thick
- 30 mm (1.2") Measuring material up to 30 mm thick
- 60 mm (2.4") Measuring material up to 60 mm thick
- 100 mm (4") Measuring material up to 100 mm thick
- 200 mm (8") Measuring material up to 200 mm thick

In Multiple Echo mode the A-Scan graph axis is set to 4 times the A-Scan Range setting – this is ensure at least three back wall echoes can be displayed. *Example 15mm x 4 = 60mm.*

In Single Echo mode the A-Scan graph axis is set to the A-Scan Range setting – this is because you only need to see one back wall echo.

The A-Scan range setting does not affect the thickness measurement.

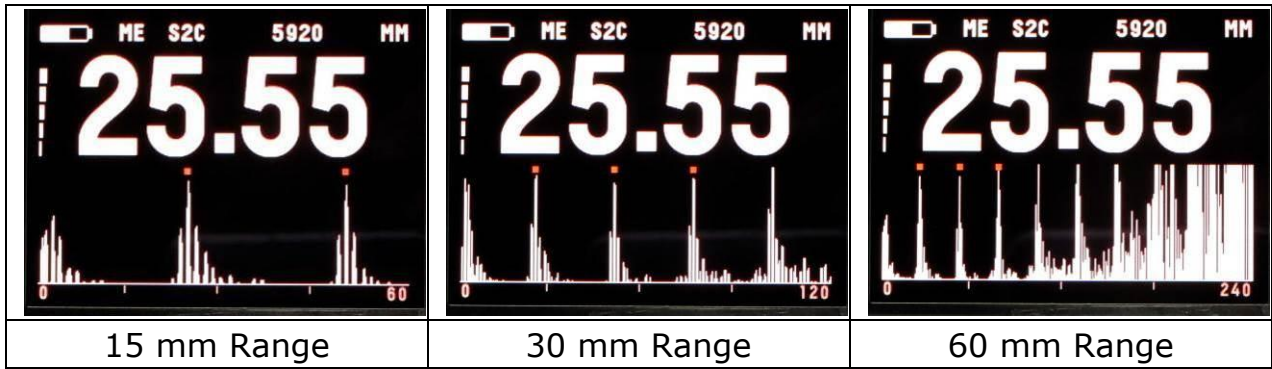

To change the A-Scan Range setting select A-SCAN RANGE from the Main Menu.

Turning the A-Scan Display On or Off (A-SCAN DISPLAY)

The A-Scan Display can be turned off if not required. Select A-SCAN DISPLAY from the Main Menu.

You can also turn the A-scan display on and off by pressing the right button when the measurement screen is displayed.

Note. In Single Echo mode the A-Scan display will always be displayed and cannot be turned off.



A-Scan Setup Screen

Setting the Velocity of Sound (VELOCITY)

The gauge uses the Velocity of Sound value to calculate the material thickness value. You must set the velocity of sound to match the material being measured. A table on page 110 lists velocity of sound values for common materials.

To adjust the velocity select VELOCITY from the Main Menu.

The probe must not be measuring or in contact with a surface to set the velocity.

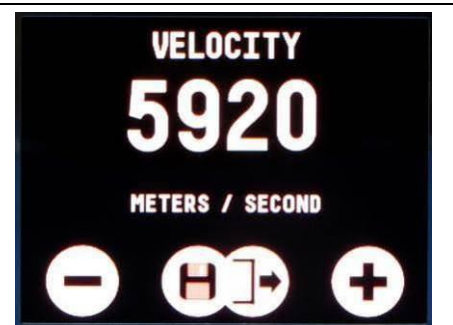



Velocity Screen

Calibrating to a Known Thickness (CALIBRATE)

This method of calibrating the gauge is more accurate than using a standard velocity value as the gauge calculates the velocity of sound for the sample material.

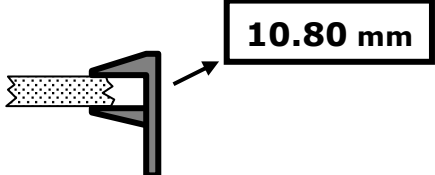
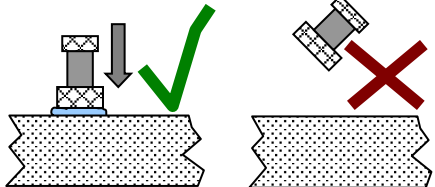
You can use this calibration method for both Multiple and Single Echo modes.

Calibrating to a Known Thickness		
1	Accurately measure the thickness of your sample material	
2	Place the Probe on the sample...	
3	...the gauge should be displaying a thickness value.	
4	Select CALIBRATE from the Main Menu	
5	Press the Left Button to decrease the thickness value. Press the Right Button to increase the thickness value. <i>Holding down either button will fast-change the value.</i>	
6	If the probe loses contact with the measurement surface during calibration the screen will display	

Calibrating to a Known Thickness		
	the echo bars. You must keep the probe on the measurement surface during calibration.	
7	Press Both Buttons to Save the calibrated thickness value and Exit.	

Two Point Calibration (CALIBRATE 2 POINT)

The Two Point Calibration option is only available in Single Echo mode.

Two point calibration allows the gauge to be calibrated against two reference thicknesses of the same material, one at the minimum (thin) thickness range the other at the maximum (thick) thickness range.

! **To achieve maximum accuracy in Single Echo mode you must perform a Two Point Calibration – your measurement is only as good as your calibration.**

When performing a two point calibration both sample thicknesses should be made from the same material. The temperature of the sample material should be the close to the temperature of the material to be measured.

The gauge will automatically compensate for v-path error in addition to either single or two point calibrations.



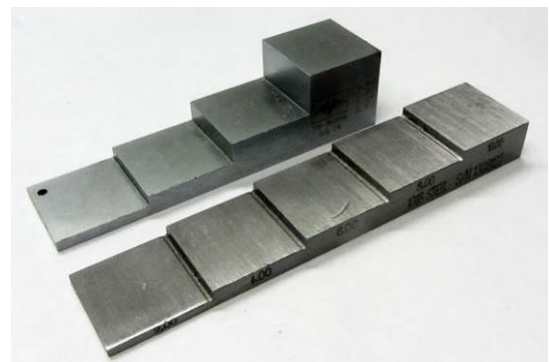

Ladder Step Wedge

Typically a Ladder Step Wedge is used to calibrate the probe and gauge for Steel. The ladder step wedge has 4 or 5 different thicknesses typically ranging from 2.5 mm to 20.0 mm. You would typically choose to calibrate using the 2.5 and 20 mm thicknesses.



Ladder Step Wedges

Two Point Calibration Procedure

Two Point Calibration Procedure		
<p>1</p>	<p>First perform a Probe Zero function.</p>	 <p>The screen displays the following text: T2C PROBE, ZEROING PROBE, WIPE PROBE FACE CLEAN, and PRESS ANY BUTTON TO CONTINUE.</p> <p>Probe Zero Screen</p>
<p>2</p>	<p>You must first determine the two calibration thicknesses you will be using. Then set these two thickness values in the gauge’s Calibrate 2 Point menu.</p>	 <p>The menu displays the following options: SET MIN THICKNESS, SET MAX THICKNESS, and CALIBRATE 2 POINT. Navigation icons for back, home, and forward are shown at the bottom.</p> <p>Calibrate 2 Point menu</p>
<p>3</p>	<p>Set the minimum thickness value;</p> <p>Select SET MIN THICKNESS from the menu</p> <p>Use the left and right buttons to change the value – press both to save and exit.</p>	 <p>The screen displays: MIN THICKNESS, 02.50, and the instruction: Set the Minimum Thickness you will use for the 2 Point Calibration. Navigation icons for minus, home, and plus are shown at the bottom.</p> <p>Set Min Thickness</p>
<p>4</p>	<p>Set the maximum thickness value</p> <p>Select SET MAX THICKNESS from the menu</p> <p>Use the left and right buttons to change the value – press both to save and exit.</p>	 <p>The screen displays: MAX THICKNESS, 020.00, and the instruction: Set the Maximum Thickness you will use for the 2 Point Calibration. Navigation icons for minus, home, and plus are shown at the bottom.</p> <p>Set Max Thickness</p>

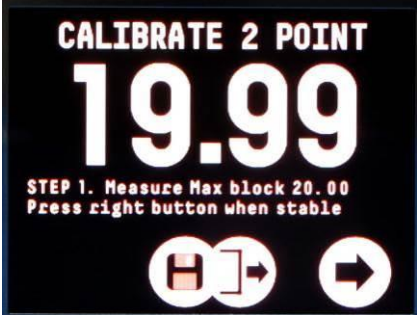
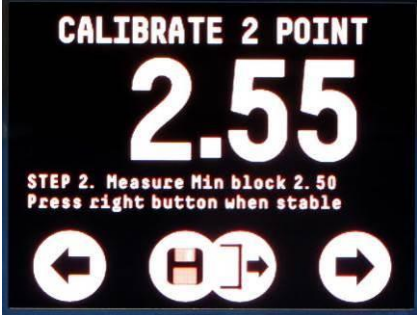
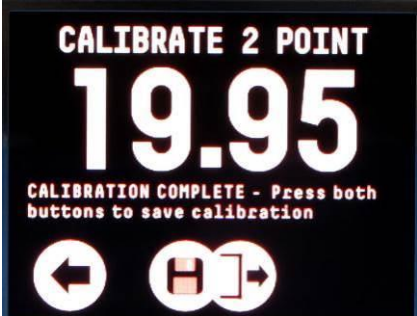
<p>5</p>	<p>Now you can perform the calibration.</p> <p>Select CALIBRATE 2 POINT from the menu</p>	
<p>6</p>	<p>Place the probe firmly on the thick calibration piece</p> <p>When the measurement displayed is stable press the Right button once</p>	
<p>7</p>	<p>Next place the probe firmly on the thin calibration piece</p> <p>When the measurement displayed is stable press the Right button once – this will perform the calibration based on the values seen</p>	
<p>8</p>	<p>Check the new thickness value displayed is acceptable. If not you can press the Left button to go back and repeat.</p> <p>Press both buttons to save and exit</p>	

Zeroing the Twin Crystal Probe (ZERO PROBE)

This only applies to Single Echo mode.

Twin crystal probes must be zeroed to compensate for any wear or operating temperature changes. The gauge will always perform a Probe Zero when first turned on or when a twin crystal probe is connected.

If the probe gets significantly warmer during use this can cause a shift in the zero position and thus introduce small errors in the thickness measurement. Typically over a 20° C change in temperature the measurements can shift by 0.1 mm.



It is recommended to frequently re-zero the twin crystal probe if conditions such as temperature are changing.

There is a ZERO PROBE option in the main menu – just select this to re-zero the probe at any time.

Material Velocity of Sound List (MATERIAL LIST)

The gauge holds a list of 8 common materials and their typical velocity of sound values;

NO CHANGE
MILD STEEL
STAINLESS 302
STAINLESS 314
STAINLESS 316
STEEL DUPLEX F51
ALUMINIUM ALLOYED
CAST IRON GREY
BRASS NAVAL

You can use the material list to quickly set the gauge to measure different materials.

If you decide not to change the material simply select the **NO CHANGE** option.

When the material is selected the gauge will display a brief confirmation message.

This list uses typical velocity values, in practice the actual velocity will vary according to the precise grade and processing conditions of the material being measured.

 **This list is provided as a guide only. Wherever possible, the Gauge should always be calibrated on the material under test.**

These Velocities are given in good faith and are believed to be accurate within the limits described above. No liability is accepted for errors.



Material List Screen



Mild Steel



Stainless 316



Material Changed Screen

Measurement Units (UNITS)

The gauge can display the thickness measurement in mm or inches.

To change the units select UNITS from the Main Menu.

Changing the measurement units will not affect the calibration.



Units Setup Screen

Thickness Measurement Resolution (RESOLUTION)

Multiple Echo Mode

The gauge can display the thickness measurement in 0.05mm or 0.1mm resolutions (0.002 or 0.005 Inch)

To change the resolution select RESOLUTION from the Main Menu.

Decreasing the resolution may help the gauge to obtain a Multiple Echo thickness measurement on heavily corroded materials as the return echoes don't have to be matched as precisely.

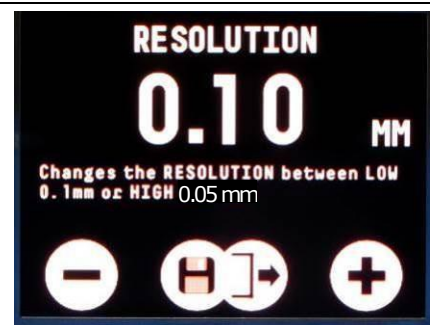

Resolution Setup Screen

Single Echo and Echo-Echo Modes

The gauge can display the thickness measurement in 0.01mm or 0.1mm resolutions (0.001 or 0.005 Inch)

To change the resolutions select RESOLUTION from the Main Menu.

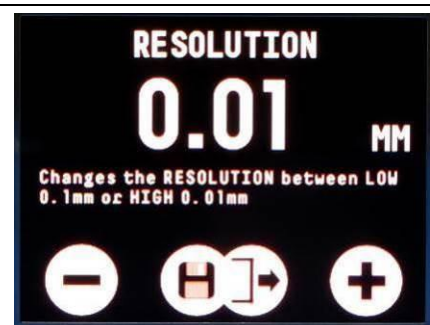

Resolution Setup Screen

Deep Coat Feature (DEEP COAT)

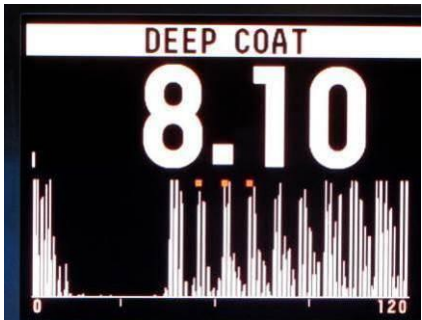
<p>In Multiple Echo mode with the Deep Coat OFF the gauge can measure through most protective coatings up to 3 mm (0.11") thick, coatings like paint, anti-foul, hard plastics and epoxy should present no problems as long as they have not de-laminated/de-bonded from the metal surface.</p>	 <p>Deep Coat On/Off Screen</p>
<p>In Multiple Echo mode with Deep Coat turned ON will allow the gauge to measure through coatings over 3 mm (0.11") thick up to a maximum of around 20 mm (0.78") depending on the properties of the coating material. Measuring through thick coatings is ultimately limited by how well the coating material transmits the ultrasound, soft coating like rubber or bitumen don't transmit ultrasound very well.</p> <p>If you need to measure through a coating over 3 mm thick then you will have to turn Deep Coat ON. Using Deep Coat will not affect the calibration.</p> <p>Note. Deep Coat is only available in Multiple Echo mode.</p> <p>To turn Deep Coat on or off select DEEP COAT from the Main Menu.</p>	 <p>A warning message is flashed at the top of the measurement screen when Deep Coat is turned on.</p>

Changing the Measurement Mode (MEASURE MODE)

When a twin element probe is connected you can select either Single Echo or Echo-Echo measurement mode as required. (See Measure Modes on page 29 for more information.)

To change the measurement mode from the Main Menu simple access the menu and scroll down to MEASURE MODE. Select this item and use the buttons to switch between Single Echo (SE) or Echo-Echo (EE) modes.

Probe Type Selection (PROBE TYPE)

The gauge can automatically detect the following probe types when the probe type is set to AUTO;

- S2C Probes
- T5B Probes
- T2C Probes

If you have a S3C, S5C or S5A probe then you will need to manually set the probe type to match the probe being used.

To change the probe type select PROBE TYPE from the Main Menu.

! The probe type must be correctly set to match the probe being used otherwise thickness measurements will be impossible or incorrect.



Probe Type = AUTO



Probe Type = S2C

Setting the Power Save Timer (POWER-SAVE TIMER)

The gauge has a power save feature that helps to increase battery life when the gauge is not measuring.

1. First, after a period of inactivity, the thickness measurement and A-Scan graph will be turned off and the gauge measurement scan rate will slow down.

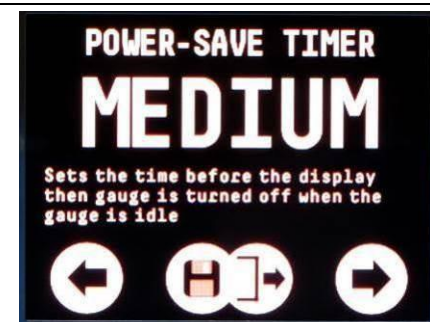

Power Save Timer Setup Screen

2. After a further period of inactivity the whole display will be turned off.
3. Finally, after further inactivity, the gauge will enter standby mode.

If you start taking measurements in 1. or 2. the gauge will revert back to full power mode.

To turn the gauge back on from standby simply press either button for 5 seconds until the screen turns back on.

The amount of inactivity time can be selected from 3 choices:

- Short 1 minute to off
- Medium 2 minutes to off
- Long 5 minutes to off

Note. Keeping the backlight on for longer will reduce the battery life.

To change the power save setting select POWER SAVE TIMER from the Setup Menu.



Measurement and A-Scan turned off

Calibration Lock Feature

The gauge has the facility to lock the Velocity value, the Units and the Resolution settings. This feature can be used by a survey manager to prevent users from altering the calibration settings during a survey.

To activate the Calibration Lock facility please contact Cygnus Instruments for instructions.

13. Data Logging

The DIVE gauge has a Data Logging feature that can be enabled either when the gauge is purchased or enabled afterwards by the user after purchasing a software enabling utility.

The Data Logging feature allows the user to log up to 5000 thickness measurements, including the A-scan graph, to the gauge’s internal memory. These measurements are then retrieved from the gauge by connecting to a computer which has Cygnus CygLink installed, the logged measurements are then transferred in to the computer and can be presented as a report, saved, emailed or exported to a spread-sheet application.

The gauge uses an AutoLog feature to enable the diver to data log measurements without pressing any buttons. Because the AutoLog feature works on timing it is best to practice data logging before the dive so you understand how to log the desired measurements.

AutoLog Feature

To remove the necessity for a “log” button but still enable the diver to log measurements the AutoLog feature was developed. The AutoLog feature uses timing of ‘stable measurements’ and ‘no measurements’ to decide when to log a reading.

To data-log a measurement the diver simply HOLDS the probe stable maintaining the measurement for a minimum set time – the measurement is then automatically logged. To allow the next measurement to be logged the diver must then RELEASE the probe from the surface for a minimum set time – the gauge is ready to log the next measurement when required.

In summary to Auto Log a measurement:

1	The diver places the probe on the surface and obtains a stable thickness measurement.
2	The diver Holds the probe still and maintains the stable thickness measurement.

3	After the set hold time the thickness measurement will be logged and the thickness measurement will flash to signal to the diver.
4	The diver removes the probe from the surface for at least the set release time.
5	For the next measurement repeat again from step one.

Grouping Measurements

The gauge logs each thickness measurement sequentially, each measurement has an ID number which is increased by 1 for each measurement logged. Each measurement also contains a GroupID number enabling you to further group the measurements. The GroupID number is always incremented when a new data logging session is started, but the diver can also start a new group whenever they choose by using the Start New Group option in gauge’s data logging menu (see page 71)

The Group ID number can therefore be used to separate measurements when producing the report.

Measurement Screen while Data Logging

When the gauge is data logging the measurement screen will show details of the last few measurements and the number logged.

When the A-scan display is turned on the display will look like;



The last 3 logged measurements

The total number of measurements logged

When the A-scan display is turned off the display will look like:



The last 5 logged measurements logged and their ID number

The total number of measurements logged and the current GroupID

Starting a Data Logging Session (START LOGGING)

This function begins a new data logging session and starts logging measurements to the gauge's memory, the GroupID number will be increased by 1. New measurements will follow on from any existing measurements already logged in a previous session.

To start data logging;

1. Access the DATA LOG MENU
2. Select START LOGGING
3. Change from NO to YES
4. Press both buttons together to save and exit



Start Logging Screen

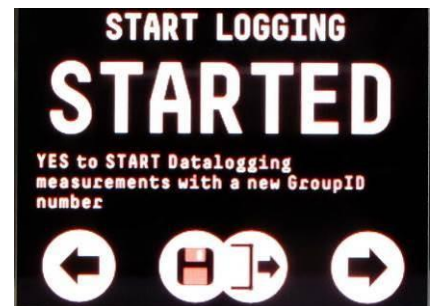

Started Message

Ending a Data Logging Session (STOP LOGGING)

This function will finish data logging and prevent the gauge from logging any more thickness measurements. You can start data logging again in the future and any new measurements will follow on from the group you are completing now.

To stop data logging;

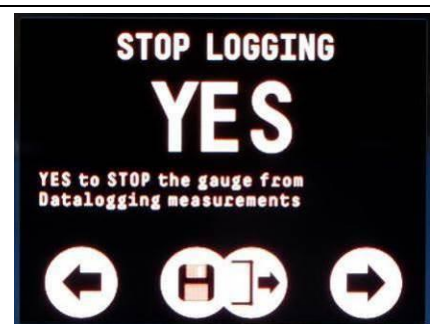

Stop Logging Screen

<ol style="list-style-type: none"> 1. Access the DATA LOG MENU 2. Select STOP LOGGING 3. Change from NO to YES 4. Press both buttons together to save and exit 	 <p>Stopped Message</p>
--	--

Starting a new Group of Measurements (START NEW GROUP)



<p>At any time while you are data logging you can use this function to start a new group of measurements by increasing the GroupID by 1.</p> <p>To start a new group;</p> <ol style="list-style-type: none"> 1. Access the DATA LOG MENU 2. Select START NEW GROUP 3. Change from NO to YES 4. Press both buttons together to save and exit 	 <p>Start New Group Screen</p>
---	--

Deleting the Last Measurement (DELETE LAST)

<p>This function will delete the last measurement logged one at a time.</p> <p>You can repeatedly use this function to delete multiple measurements.</p> <p><i>Note. Once deleted measurements can't be recovered.</i></p> <p>To delete the last measurement;</p> <ol style="list-style-type: none"> 1. Access the DATA LOG MENU 	 <p>Delete Last Screen</p>
---	---

<ol style="list-style-type: none"> 2. Select DELETE LAST 3. Change from NO to YES 4. Press both buttons together to delete and exit 	 <p style="text-align: center;">Deleted Message</p>
--	--

Clearing the Data Logger Memory (CLEAR MEMORY)

<p>You can delete <u>all</u> the measurements from the gauge's memory ready to start a new survey.</p> <p>To clear the data logger memory;</p> <ol style="list-style-type: none"> 1. Access the DATA LOG MENU 2. Select CLEAR MEMORY 3. Change from NO to YES 4. Press both buttons together to save and exit <p><i>Note. There is no Undo function, once deleted measurements can't be restored.</i></p>	 <p style="text-align: center;">Clear Memory Screen</p>  <p style="text-align: center;">Cleared Message</p>
---	---

Viewing the Data Logging Status (DATA LOGGER STATUS)

The Data Logger Status screen shows the number of measurements taken and how many remain and the GroupID number.

To view the status;

1. Access the DATA LOG MENU
2. Select DATA LOGGER STATUS
3. Press both buttons together to exit



Data Logger Status Screen

Setting the AutoLog RELEASE period (DLOG RELEASE TIME)

The period of time the diver must Release the probe from the surface before the next thickness measurement can be Auto Logged.

AutoLog Release is set by a timer, the value is in seconds and can range between 0.25 and 4 seconds in steps of 0.25 seconds.

To set the release time;

1. Access the MAIN MENU
2. Then select the SETUP MENU
3. Select DLOG RELEASE TIME
4. Change as required
5. Press both buttons together to save and exit

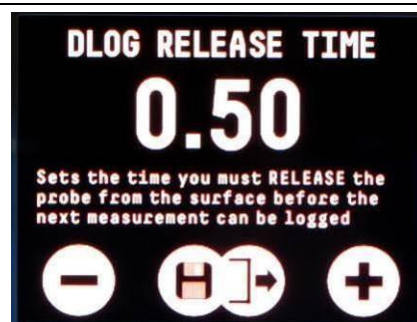

Data Logger Release Setup Screen

14. HelmetView Remote Display

HelmetView is an optional remote display that can be mounted on a Kirby Morgan® dive helmet using an accessory screw. The display will show the measured thickness value or the echo bars just like the DIVE's display. HelmetView enables the diver to view thickness measurements in limited visibility or black water.



HelmetView is supplied as a remote display unit with 1.5 meters of cable with connector and a mounting bracket to suit the Kirby Morgan® helmets.

HelmetView is simply plugged into the spare connector on the opposite side to the probe cable. When the DIVE gauge is turned on the remote display will reflect the gauge's display.

Fitting the Mounting Bracket

The mounting bracket is screwed to the rear of the HelmetView display using two M3 x 6mm screws.



HelmetView Unit Fixed to Mounting Bracket

The bracket is then fixed to the Kirby Morgan® helmet using the left hand side accessory screw. The cable will exit to the rear of the helmet and the display will be visible in the top of the lens.

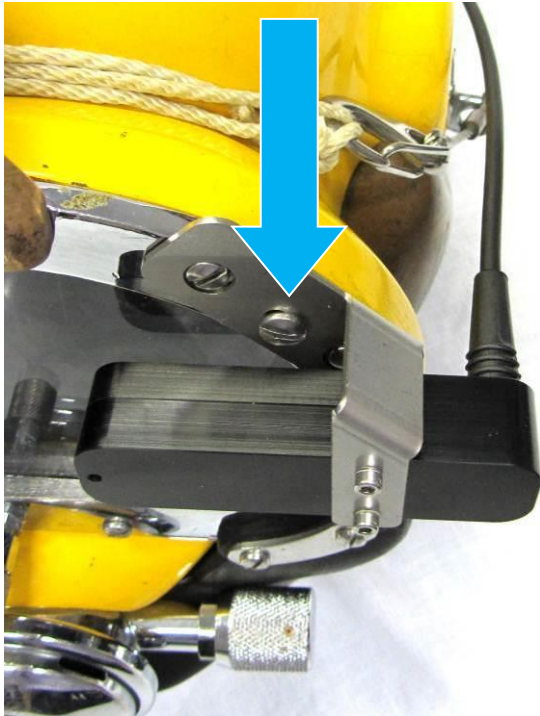

Accessory Screw

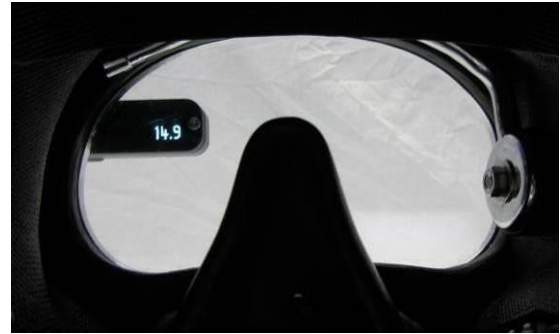

View from Inside the Helmet

15. Topside Repeater Remote Display Kit

The Cygnus Topside Repeater Display (TSR) unit is a remote display unit with an LCD display that mimics the thickness measurement value displayed on the DIVE gauge. It connects directly to the DIVE gauge via the RS485 single-pair umbilical cable link. An optional Video Overlay feature is available which will overlay the thickness measurement onto a composite PAL or NTSC video signal.



Mk4 Cygnus Topside Repeater - TSR.

Part Numbers

The TSR kit can be supplied as an additional feature with any DIVE gauge either from new or separately at a later date. For the part number see Accessories on page 105.

Kit Contents

The TSR kit comprises of the following items;

1. Topside Repeater Display Unit.
2. Video Cables and DC Power Supply when supplied with Video Overlay option.

You will also need a Umbilical cable and connectors to connect the DIVE gauge to the top side. Cygnus can supply the complete

umbilical cable with connectors fitted, or the customer can make their own umbilical cable using connectors supplied with cable tails.

Operation

Turning the Unit On

To turn on the TSR simply press the key with the Red Triangle, the Cygnus Logo screen will then be displayed. If not connected to a DIVE gauge the display shows "NO CONNECTION".

This is normal – it just means no data is being received yet.

Turning the Unit Off

To turn the unit off press the key with the Red Triangle.

Changing the Displayed Units

To change the displayed measurement units between metric (mm) and imperial (inch) press the left MENU key, the UNITS setting will be highlighted, then press the middle EDIT key to change the units.

Display Hold Function

Whilst measuring, the middle key HOLD can be used to freeze the display and hold the current thickness measurement. Press the middle key again to release the HOLD function.

Automatic Display Backlight

The display backlight automatically turns off in bright light conditions, it will automatically turn on when the ambient light level drops.

Connecting to the DIVE Gauge

An umbilical cable is used to connect the DIVE gauge to the Topside Repeater Display unit.	
--	--

The Lemo connector plugs into the top of the Topside Repeater Display unit.

Align the red marks on the plug and socket.



Remove the blanking plug from the spare connector on the DIVE gauge.

The plug on the umbilical plugs into the socket on the DIVE gauge.

Testing the Link

Before use on a dive it is recommended to test the link between the DIVE gauge and the Topside Repeater (TSR) display unit. To do this simply power on both the TSR and the DIVE gauge then measure the test block – the TSR should display the same measurement as the gauge.

Changing the Batteries

The non-video overlay TSR operates from 2 x AA batteries. To change the batteries unscrew the round battery cover from the bottom of the TSR unit, the batteries can then be removed and replaced. When replacing the battery cover, screw only finger tight.

Topside Repeater with Video Overlay

The TSR is available with a Video Overlay function that will display the thickness measurement on a composite video signal, this allows the thickness measurement to be viewed on the topside monitor screen, and also recorded if video recording is being used.

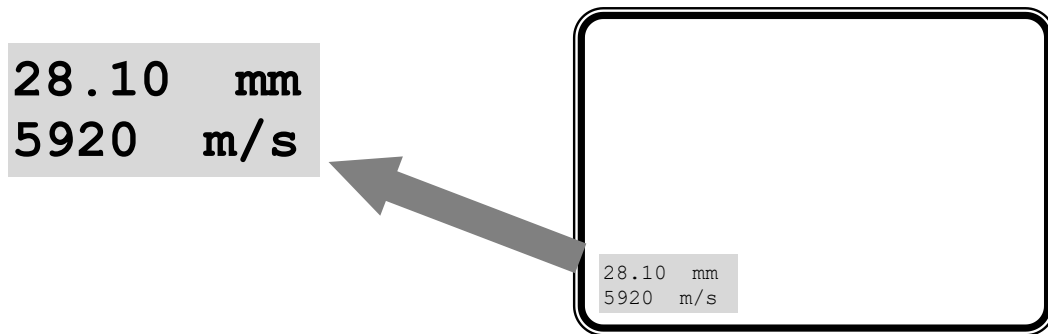

The TSR with Video Overlay operates from an external DC power supply - there are no batteries required.

Connecting the Video Signal

The TSR has two BNC sockets on its top panel; Video In and Video Out. The video feed to the monitor and video recorder is fed through the TSR. The TSR will automatically detect and adjust for PAL or NTSC video signals, it will work with colour or monochrome images.

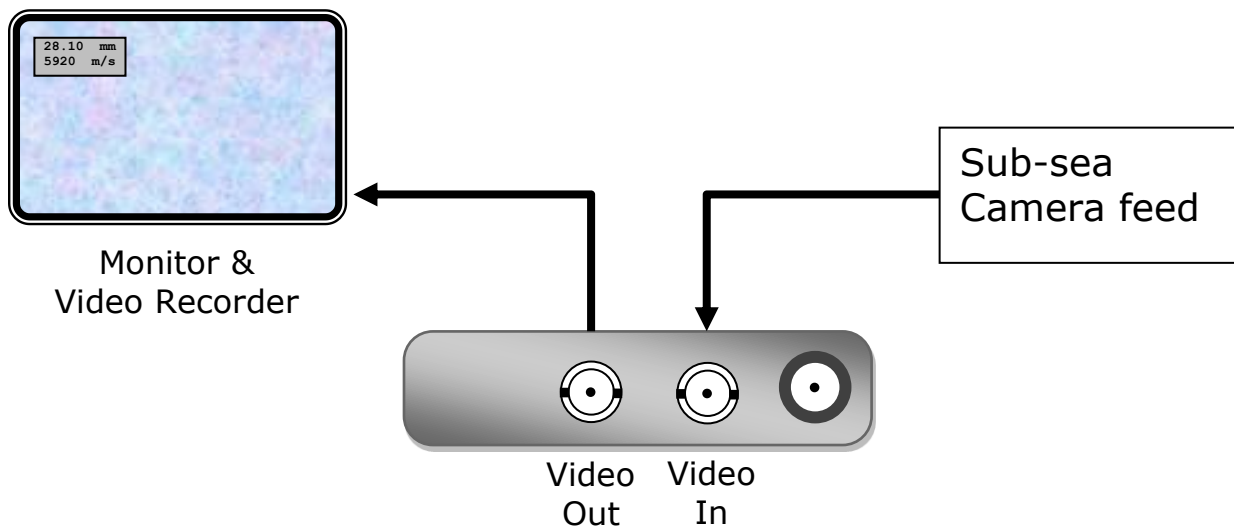

Positioning the On-Screen Display

Because there is usually other information displayed on the video screen the TSR has the facility to move the thickness measurement display 'box' to anywhere on the screen using X, Y coordinates. The position selected will be stored in the TSR memory during power off.

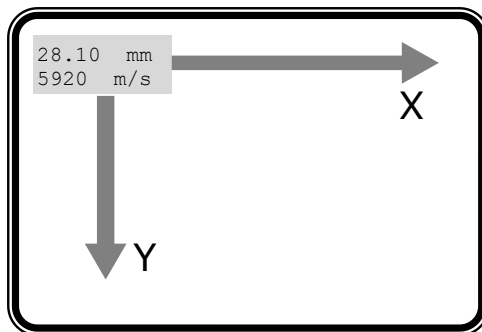

Setting On-Screen Display Position	
1	Press the MENU key to display the MENU .
2	Press the DOWN ARROW key to scroll down to OSD X POS.
3	Press EDIT to adjust the X screen position. Press EXIT to save and exit.
4	Press the DOWN ARROW key to scroll down to OSD Y POS.
5	Press EDIT to adjust the Y screen position. Press EXIT to save and exit.
6	Press EXIT again to exit the menu screen.

16. CygLink Surface Display and Control Kit

CygLink is a Windows® application for PC's that allows remote viewing, control and data logging of the DIVE gauge. The software can provide the following functionality:

1. Surface display of thickness measurements
2. Surface display of A-scan graph
3. Surface display of the gauge's battery level
4. Remote setting of the velocity of sound
5. Remote setting of the units
6. Remote control of the Deep Coat function
7. Data Logging of thickness measurements into a Survey report
8. Transferring data logged measurements out of the DIVE gauge
9. Estimation of thickness from A-scan graph and data logging of this estimated thickness value

Part Numbers

The CygLink kit can be supplied as an additional feature with any DIVE gauge, either from new or separately at a later date. For the part number see Accessories on page 105.

Kit Contents

The CygLink kit comprises of the following items:

1. USB-RS485 Converter Cable
2. CygLink Software Installer on USB Flash Drive

You will also need an Umbilical cable and connectors to connect the DIVE gauge to the top side. Cygnus can supply the complete umbilical cable with connectors fitted, or the customer can make their own umbilical cable using connectors supplied with cable tails.

Connection Diagram

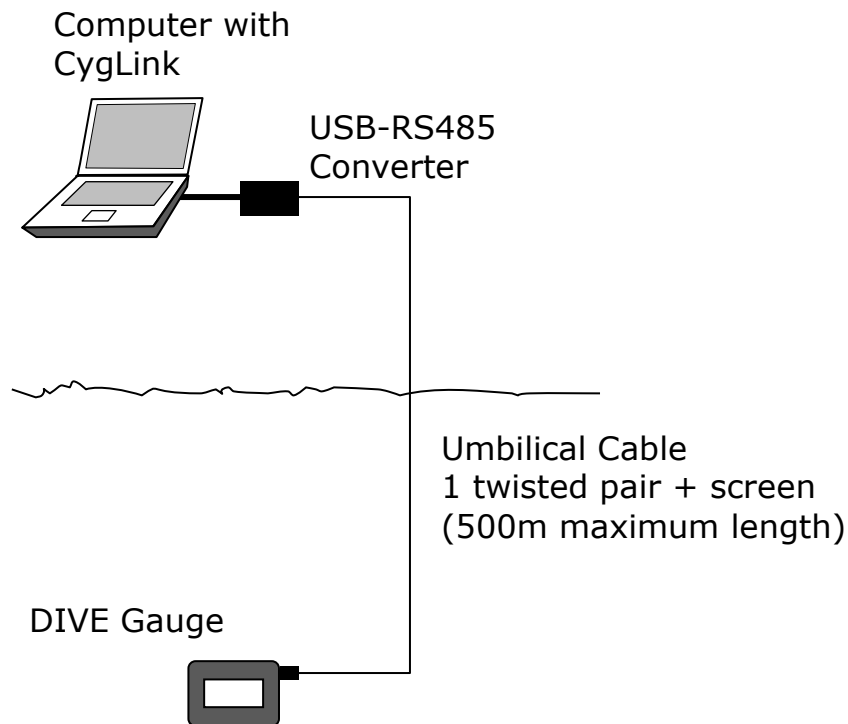

Connector Details and Signals

See Connections from page 116

Using CygLink with HelmetView

As HelmetView and CygLink both need to connect to the spare connector on the gauge a "Y" splitter cable is required. For the part number see Accessories on page 105.

Installing CygLink

CygLink V5 is supplied with the kit on a USB Flash Drive, or it can be downloaded from the Cygnus Instruments website. If you want to make sure you are installing the latest version then downloading from the website is the best route.

Requirements

To install and run CygLink the computer must:

1. Be running Windows 7 or a newer version
2. Have sufficient resources for Microsoft .NET Framework installation
3. We recommend a screen resolution of 1280 x 720 or greater
4. We recommend at least 1GB of memory

Upgrading

You can check the Cygnus Instruments website for the latest version of CygLink V5.



If you are upgrading from an older version of CygLink then you must uninstall the old version of CygLink first.

Installing

If you downloaded the CygLink installer file from the Cygnus website then this is a single self-extracting ZIP file.

Simple double click the 'setup' or 'CygLink...' exe file to start installation. You will need to agree to the license terms and conditions. There are no options to select so installation is straight forward.

will need to accept the End User Licence Agreement in order to complete the installation and a summary of its terms is provided at the start. We advise opting for the Typical setup option for the smoothest installation experience.

COM Port Numbers

CygLink should automatically find the COM port number assigned to the USB converter when you click "connect" so you don't need to search for the port number Windows has assigned.

Setting the COM Port Manually

If CygLink fails to locate the correct COM port number you can set in manually from the **File -> Communications Options** menu item. Just tick the **Manual Setup** box and select the correct COM port number.

Finding your COM Port Number

With the USB-RS485 Converter plugged into your computer, open Windows Device Manager – to do this press the Windows® key and the 'R' key together, then type "**devmgmt.msc**" into the prompt followed by enter key. In the **Ports** section, look for the USB Serial Port entry. Remember the COM number listed as this will need to be selected within CygLink's settings menu.

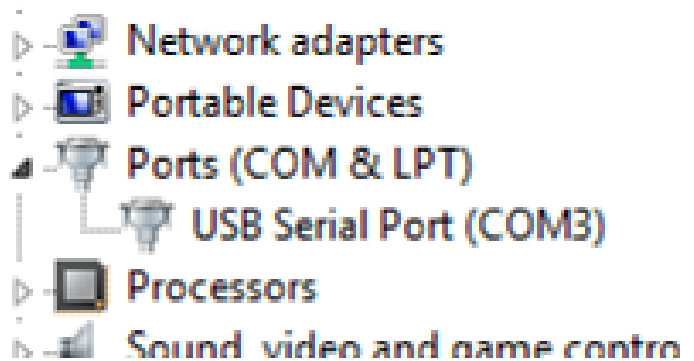
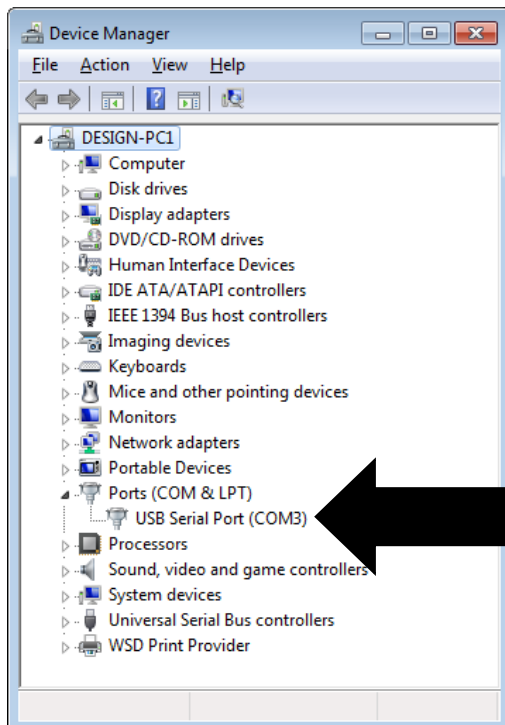

Windows® Device Manager

Connecting to the Gauge

First time USB Connection

When you first connect the gauge to the computers USB port Windows will search for a suitable driver, you may notice this message from the taskbar;

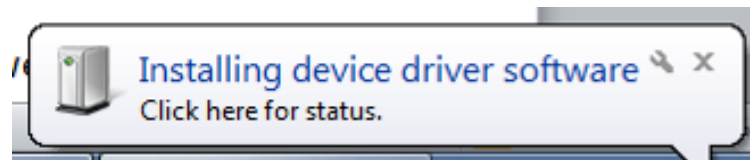

If you click the message you should see the driver installation process;

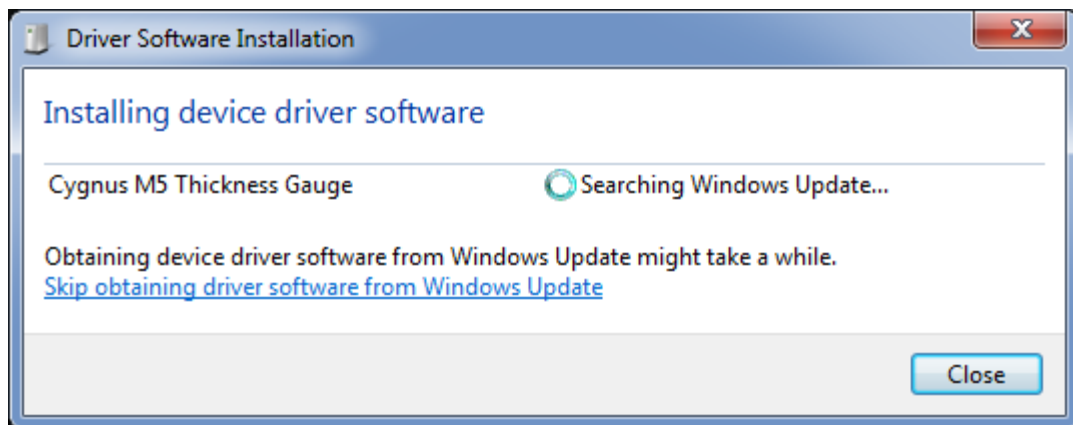

You can 'Skip' this process, but otherwise let it proceed and eventually you should see the following message;

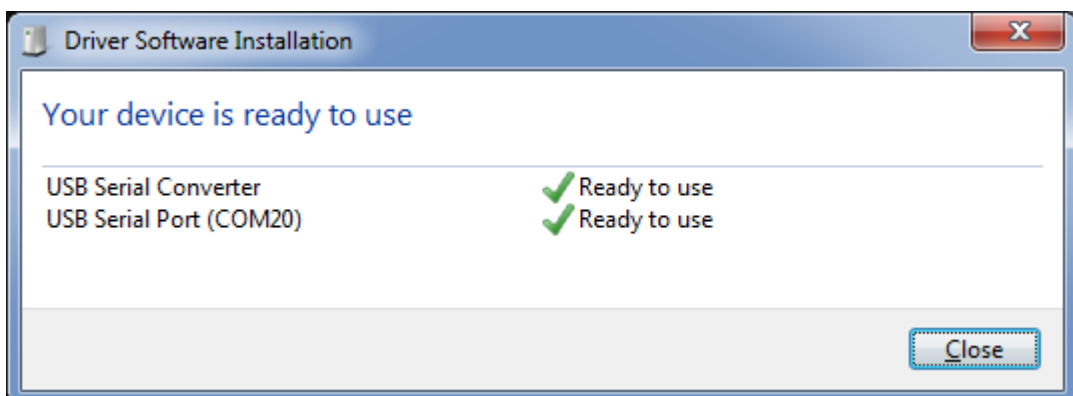

Connecting the Gauge to CygLink for the First Time

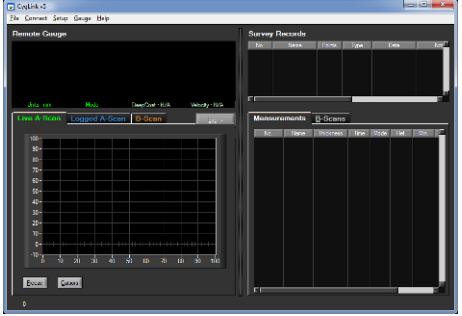
<p>1.</p>	<p>Turn on the gauge</p>	
<p>2.</p>	<p>Run CygLink V5</p>	
<p>3.</p>	<p>From the Menu click; Connect ↳ Discover new Gauge and Connect</p>	

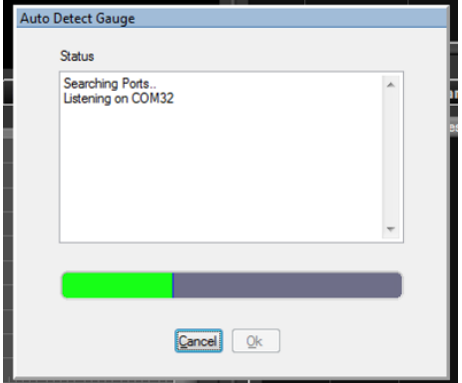
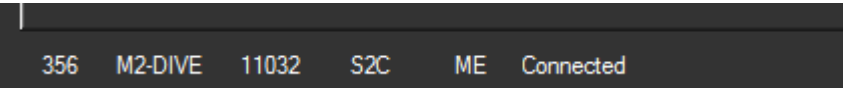
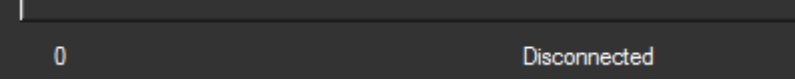
<p>4.</p>	<p>CygLink will search all the available Com ports listening for a Cygnus gauge..</p> <p>If a gauge is detected then it will connect and save these settings for next time.</p>	
<p>5.</p>	<p>When connected you should see details of the gauge in the status bar at the bottom and 'Connected'</p>	
<p>6.</p>	<p>If the connection is ever lost the status bar will show 'Lost Connection'</p>	

Connecting to the Gauge Afterwards

<p>1.</p>	<p>Once you have discovered the Gauge the connection settings will be stored for next time, so to connect next time simply click from the menu;</p> <p>Connect └ Connect to Mx-DIVE Gauge</p>	
------------------	--	--

Disconnecting from the Gauge

- 1.** To disconnect from the Gauge simply click from the menu;

Connect
└ **Disconnect from Gauge**

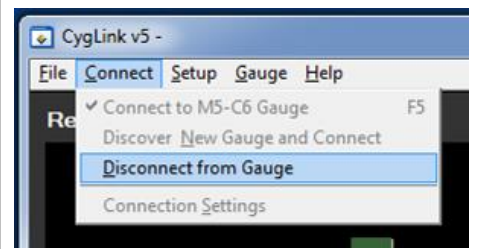

Manual Connection Settings

If you need to manually set the connection settings then select the **Connection Settings** option from the **Connect** menu, here you can specify the COM Port number, gauge type and baud rate.

Changing Gauge Settings

To change the gauge settings click **Gauge -> Measurement Settings**. You can change the Units, Measurement mode, Velocity, Deep Coat and A-Scan Range. Any changes will be sent to the gauge and also update CygLink.

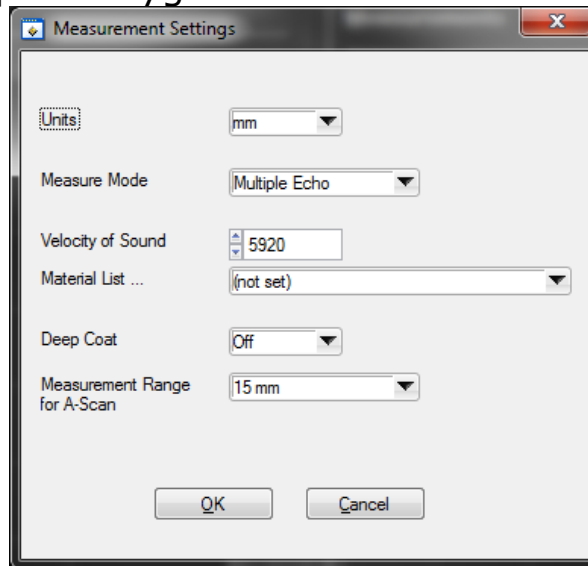

Measurement Settings Screens

Material Velocity List

You can select the Material Velocity from a list of common materials, in the **Gauge -> Measurement Settings** screen click the [▼] button to display the list.

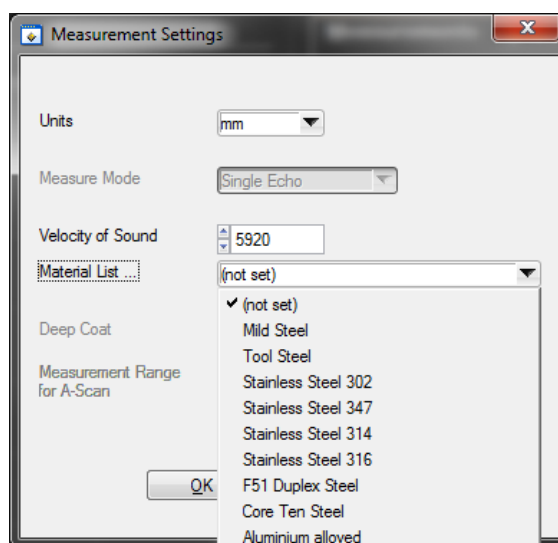

Velocity List

A-Scan Measurement Cursors

The A-Scan display can be frozen to make measurements using two cursors easier, but is not necessary to take a measurement. To freeze the display click the **Freeze** button. To display the cursors click the **Cursors** button, to move the cursors left click and hold at the cross wire intersection. The distance between them is displayed as a thickness measurement using the current velocity of sound value.

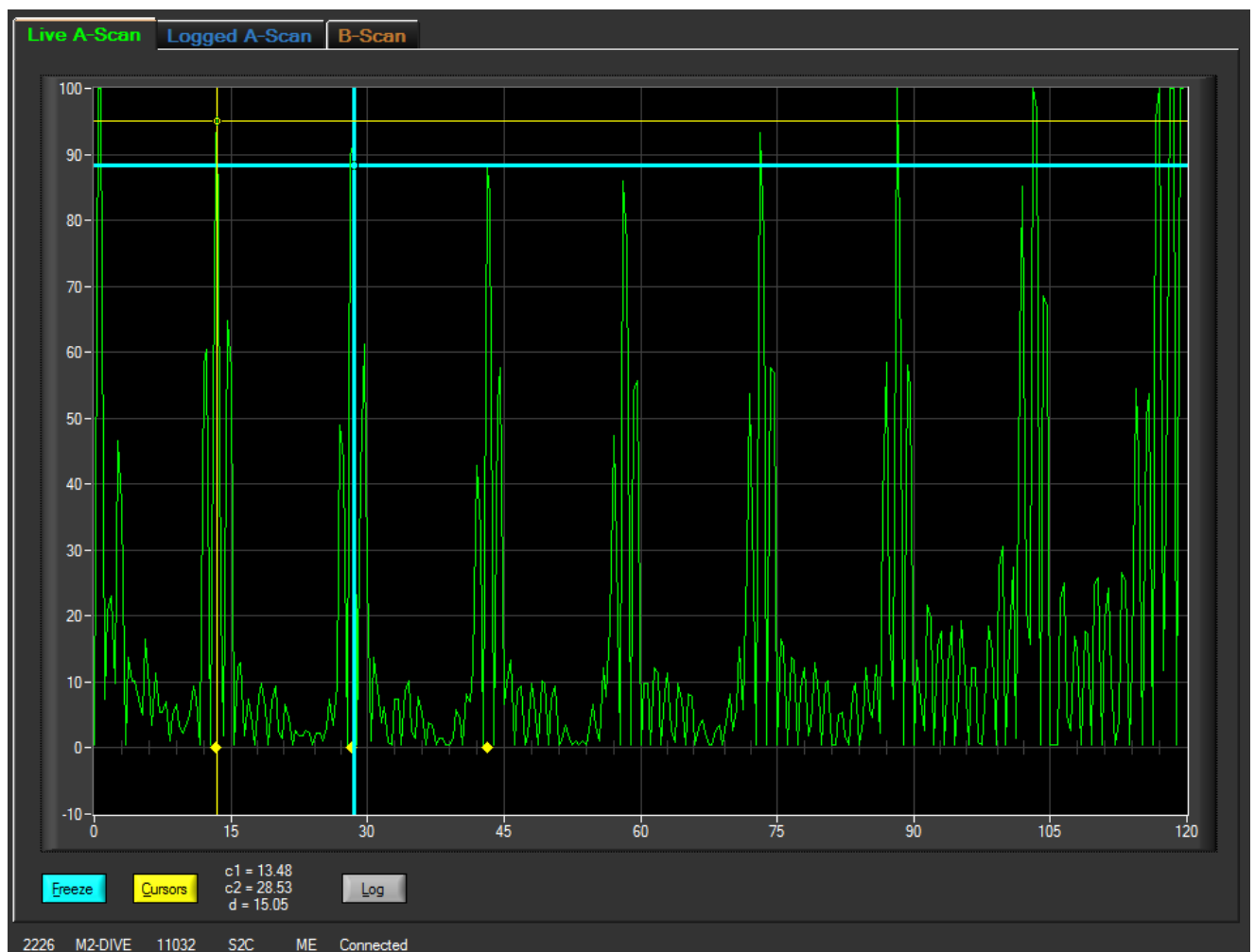

A-Scan Graph with Cursors

Using the A-Scan Cursors with Twin Crystal Probes

- ⚠ Thickness measurements made by the DIVE gauge are automatically compensated for V-path errors introduced by the twin crystal's ultrasound path. However the A-Scan graph cursor does not have V-path compensation -

therefore when using the cursor to estimate thickness measurements from twin crystal probes be aware that the estimated value could be larger than the actual thickness.

CygLink Surveys and Data Logging

CygLink have the facility to store logged thickness measurements in a single Survey file. These measurements are organised into Survey Groups, each Survey Groups can contain any number of thickness measurements. The whole Survey can be saved to a single file which can be emailed, or it can be turned into a PDF paper report and also emailed or printed out.

Survey	1 Survey
Groups	(1 to many groups)
Measurements	(1 to many measurements)

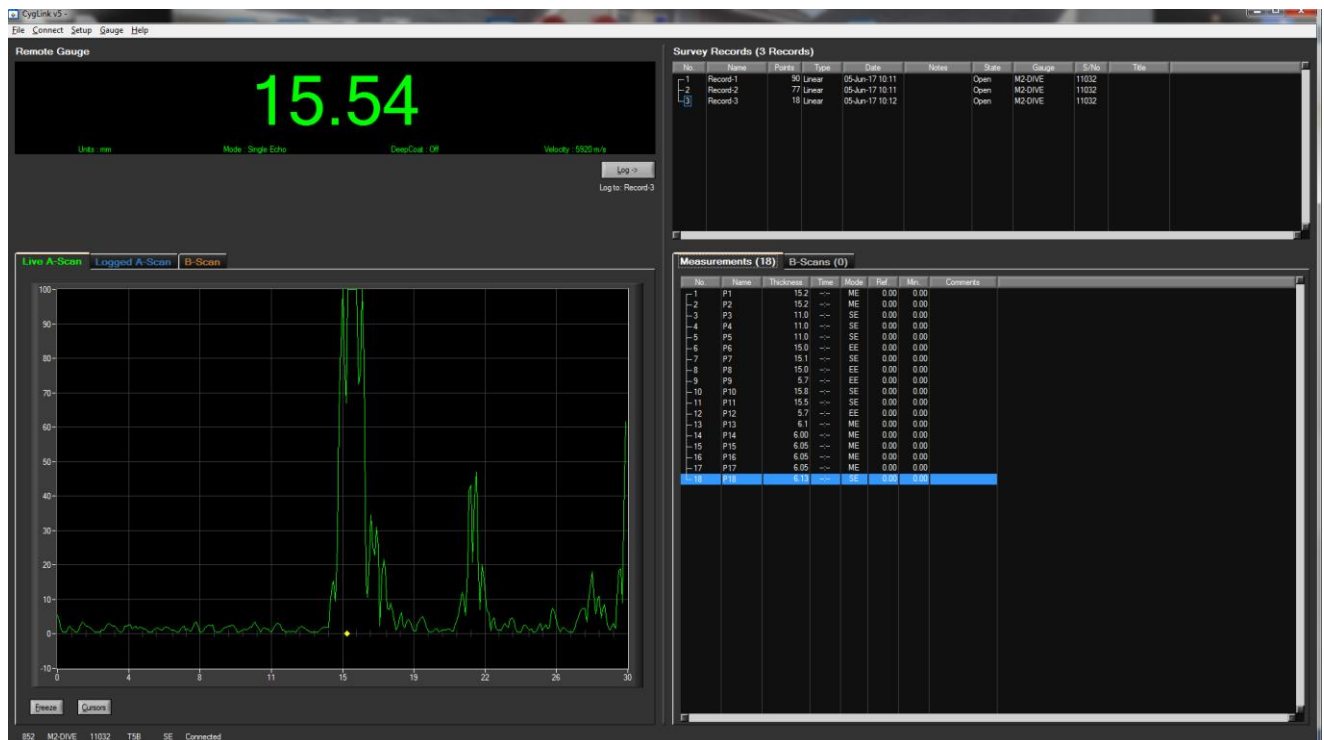

CygLink Main Screen with a Survey Group with Measurements.

You can Save, Open or Create new Surveys from the File menu;

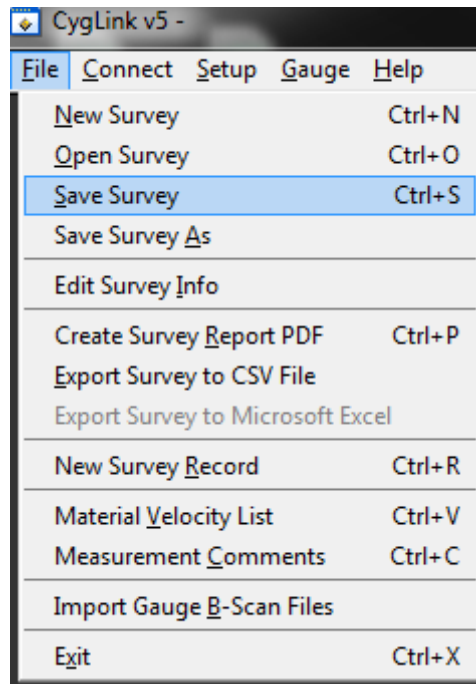

File Menu.

Editing the Survey Details

The Survey contains all the Groups and is used to save all the data. You can also add details to the Survey that will be printed at the beginning of the PDF report. To create or edit the Survey details click **File -> Edit Survey Info**.

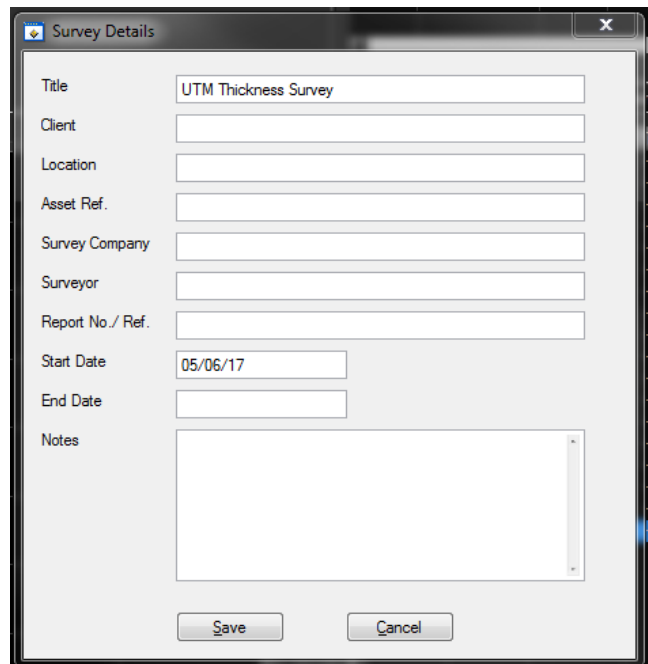

Survey Details Screen.

Editing the Survey Group Details

To view and edit the survey Group details right click on the records number and select properties.

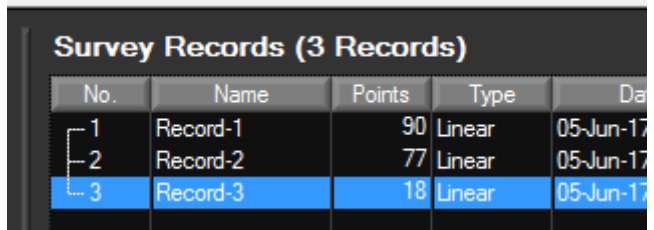

Survey Records (3 Records)				
No.	Name	Points	Type	Date
1	Record-1	90	Linear	05-Jun-17
2	Record-2	77	Linear	05-Jun-17
3	Record-3	18	Linear	05-Jun-17

To create a new Survey Group select in the File menu **New Survey Record**. File in the details as needed and press **Save**.

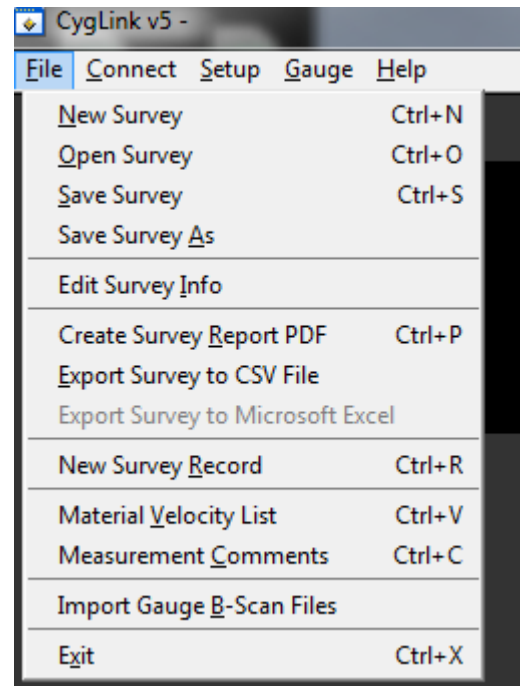

Producing a Survey Report Document

A PDF report can be produced containing all the Groups and thickness measurements in the Survey, grouped by each Survey Group. From the **File** menu select **Create Survey Report PDF**. You will be prompted for a filename first for the report first.

Once the export process is complete, your report will automatically be displayed in your installed PDF viewer. The export may take a few seconds, depending on the number of logged measurements.

Exported PDF Report Extract

Transferring Data Logged Measurements from the DIVE gauge

You can transfer all the Data Logged measurements from a connected DIVE gauge into the CygLink Survey.

From the menu select **Gauge** then **Transfer Records from Gauge**, you will then need to confirm the action;

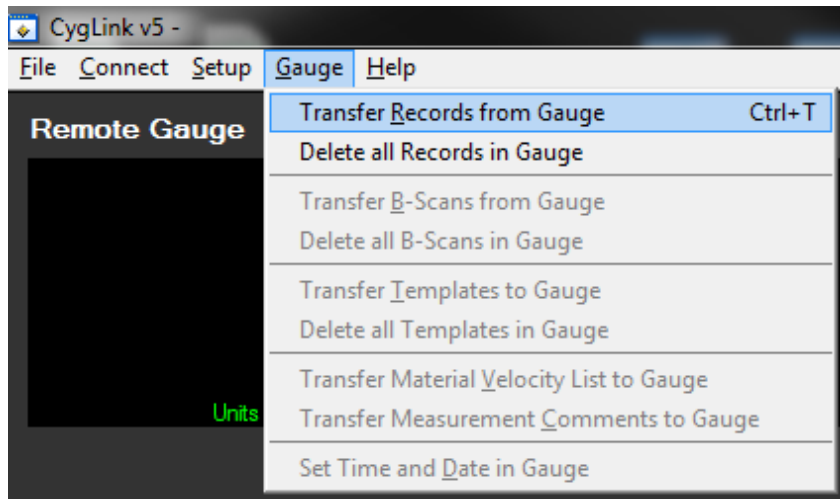

Gauge Menu.

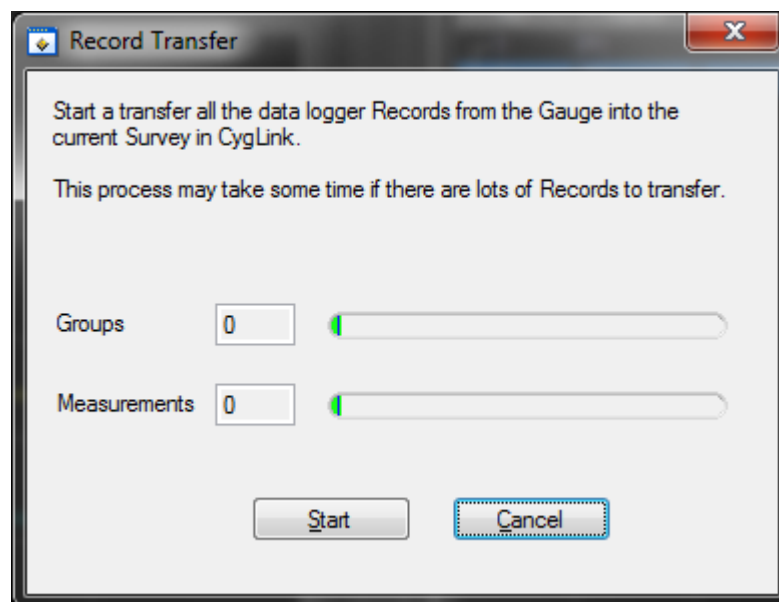

Confirm Transfer of Record from DIVE Gauge.

Note. If there are a large number of measurements logged in the DIVE gauge this process can take a few minutes to complete – be sure you have a DIVE battery that is not low in charge.

Each group of measurements in the DIVE gauge will be transferred into a new Survey Group in CygLink.

If you repeat the transfer a second time, the measurements will be appended to the Survey again in new Survey Groups.

Logging Measurements Directly in CygLink

You can use CygLink to log the displayed topside thickness measurements into a Survey so they can be presented in the Survey report.

Clicking the **Log** button next to the thickness measurement will create a new record and add a measurement into the group.

Reference and Minimum Thickness Criteria

You can set a Reference Thickness and Minimum Thickness for each survey Group right clicking on the records number and select properties. This will be applied to all measurements in the Group.

The Reference Thickness is the thickness of metal when new.

The Minimum Thickness is the minimum thickness – any measurement below this will be highlighted Red on the screen and in the survey report.

Pre-Set Measurement Comments List

You can add up to 8 short text comments that can then be used to append to a thickness measurement. To setup your comments click **File -> Measurement Comments**.

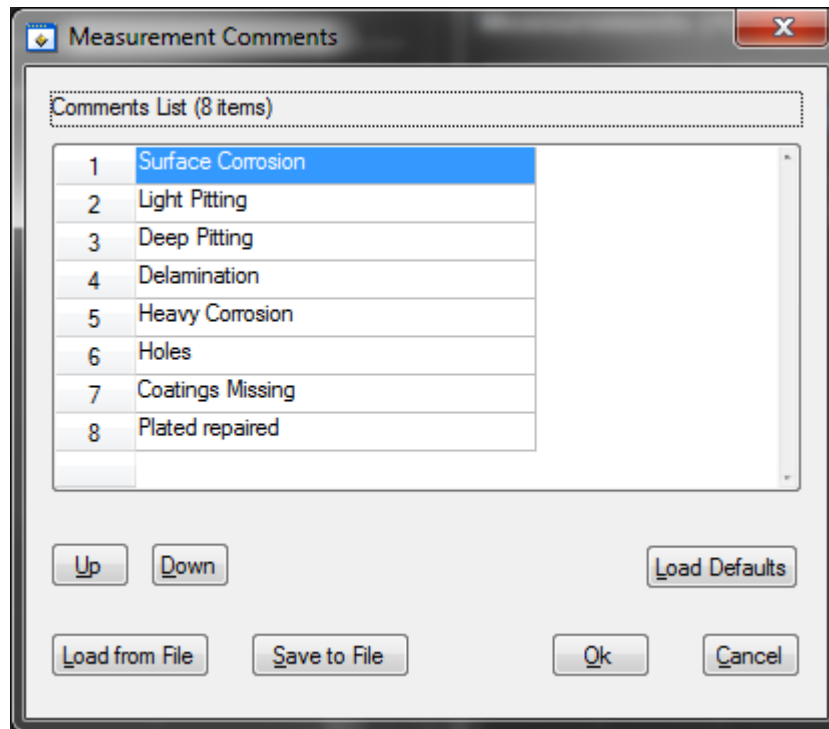

Measurement Comments Screen.

Adding Comments or Notes to a Measurement

You can add your own quick text Notes to any logged thickness measurement, just select the measurement point in the list and right click to display more options.

Click **Add Note** to type in a brief text note.

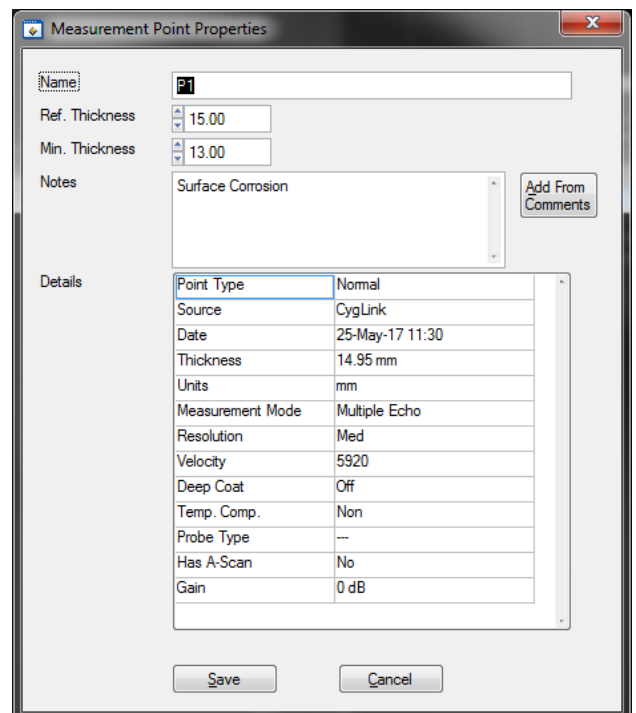

To Change the COM Port number assigned by Windows®

Depending on a variety of factors, Windows® may sometimes assign a COM Port number that is too high or unusual to be easily remembered. You may change the number assigned to the port by following these steps:

Opening Device Manager

Each version of Windows has a slightly different procedure for opening Device Manager. The most direct route is to press **Windows** + R, type "devmgmt.msc" and press Enter.

1. Select the "**USB Serial Port**" device and right click to display its context menu, Click "**Properties**".

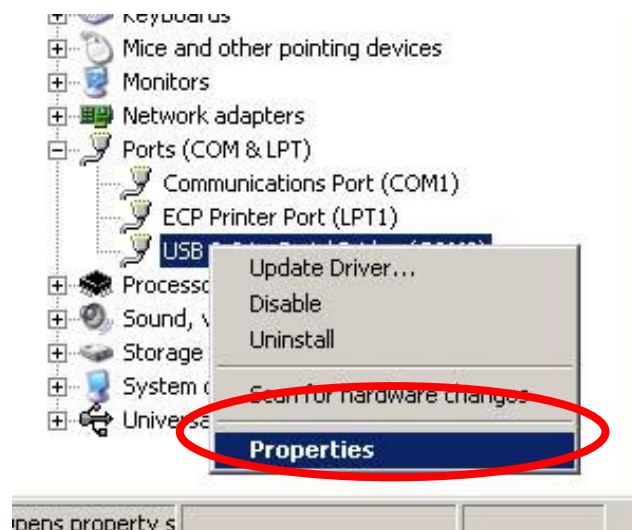

2. On the Properties form select the "**Port Settings**" tab, then click the "**Advanced**" button.

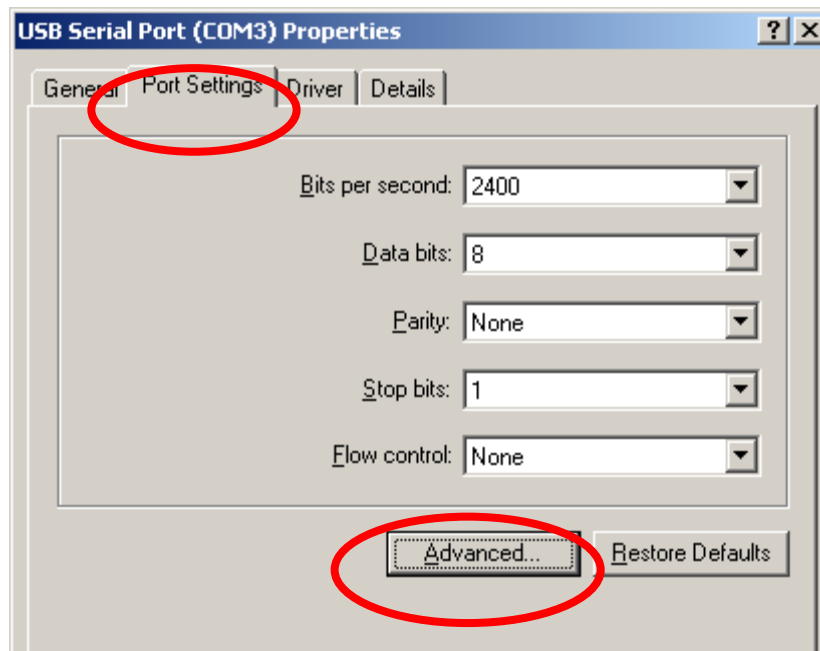

3. On the **"Advanced Settings"** form you can change the COM Port number. Finish by clicking the **"OK"** button.

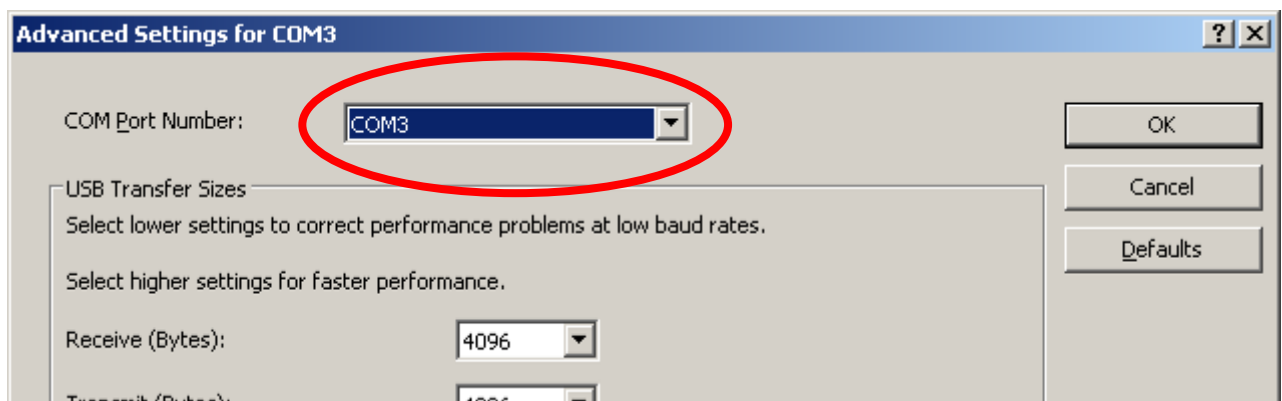

CygLink Trouble Shooting

Connection Problems – USB Drivers

If you are unable to get a connection the first thing to try is updating the USB drivers for the Serial to USB converter. Windows is constantly being updated and as a result drivers also need to be updated to keep track of changes.

The Serial to USB converter used for the DIVE gauge is manufactured by FTDI. You can search the web for the latest drivers from FTDI;

Type this into Google search "**FTDI USB RS485 Cable**"

Or follow this link directly to the FTDI website;

<http://www.ftdichip.com/Products/Cables/USBRS485.htm>

Click on the [VCP Drivers](#) link;

You will see a table of drivers with the most recent at the top. The x86 (32bit) driver is recommended.

There is a green and red LED inside the USB connector end of the cable – when installed correctly the green LED will flash every time the DIVE gauge sends data, the red LED will flash when CygLink sends data to the DIVE gauge.

Wiring Problems

Sometimes the cable between the DIVE gauge and the USB converter is damaged, or has been repaired incorrectly. Although there are only 2 data wires they must be connected the correct way around. Double check the connections from the gauge's connector to the serial converter connection.

If you have the short serial to USB interface cable – check the gauge can connect to CygLink using this cable – if it works then the USB driver must be ok, the problem may lie in the long umbilical cable.

17. General Points on Thickness Gauging using Multiple Echo Measurements

On very rough surfaces and especially if both sides are badly corroded, it is often necessary to move the probe around to locate a back wall reflector. Sometimes a slight **rocking movement** can help find reflectors which are otherwise impossible to detect.

Keep the probe face flat against the surface – the ultrasound is like a torch beam, it must be shone straight into the material so it can reflect straight back. If you tilt the probe the beam may not reflect back to the probe and you won't get a measurement.

Beware that in extreme conditions or if the plate is of poor quality and contains many inclusions the ultrasound will be scattered to such an extent that measurement may not be possible.

Beware that the multiple-echo technique will not work if the front and back surfaces of the material being measured are not parallel.

Long narrow bars cannot be gauged along their length with the multiple-echo method.

The gauge should not be used near arc-welding equipment, as this affects its performance.

18. Care and Servicing

Cleaning the Gauge

- ✓ After each dive while the gauge is still assembled, wash the unit in fresh water and allow to dry.
- ✗ Do not use solvents to clean the gauge.
- ✗ Do not use any abrasive cleaner, especially on the display window.

Batteries

- ✓ Always remove the battery after use.
- ✓ Smear some silicone grease on the battery contact face to help seal and lubricate the contacts.
- ✓ Only recharge the battery with the supplied charger.
- ✓ Occasionally⁶ give the batteries a recharge cycle of 14-16 hours to recondition the batteries and extend their life.
- ✓ Read Section 24 Shipping of Lithium-Ion Batteries on page 113
- ✗ Do not attempt to disassemble the battery, it is a sealed unit and contains no serviceable parts.
- ✗ Do not store or carry batteries in water as erosion of the exposed anode terminal will occur.
- ✗ Do not change the battery pack while underwater.

Environmental

- ✗ Do not subject the gauge to temperatures greater than 60°C (140°F).
- ✗ Do not store the gauge and its kit for long periods in conditions of high humidity.

⁶ Ideally no more than a 6 month interval.

Repairs

- ✘ There are no user serviceable parts inside the gauge. Therefore all repair work should be carried out by Cygnus Instruments or by an Authorised Cygnus Service dealer.

Returning the Gauge for Servicing

A full Manufacturer's Factory Service is available from Cygnus Instruments.

You must not ship faulty or damaged Lithium batteries. The battery contains no serviceable parts therefore if your battery has failed or has been damaged it must be correctly disposed of locally. Please read Section 24 Shipping of Lithium-Ion Batteries on page 113



The Complete Kit should always be returned for Service or Repair, including all Probes and Leads.

Cygnus gauges are world renowned for their reliability. Very often problems with getting measurements are simply due to the way the gauge is being used.

However, if you do need to return your gauge for Repair please let us know the details of the problem to help us guarantee the best possible service:

- Is the problem of an Intermittent Nature?
- Is there a problem turning the gauge On?
Or a problem with the gauge turning itself Off?
- Does the gauge consistently give Incorrect or Unsteady Readings?
- Is it not possible to Calibrate the gauge?

19. Replaceable Parts

Wrist Strap

The Wrist Strap may be easily removed and replaced and Cygnus can provide a wrist strap replacement kit (see page 104). Four grub screws secure the wrist strap locating pins in place, to remove the pins unscrew the two grub screws on one side only using a 1.5mm hex drive or Allen key. The pins can be removed using a small pair of pliers to feed them out. When fitting a new strap push the new pins fully into the holes then re-fit the two grub screws taking care not to over-tighten the grub screws, 10 Ncm is sufficient.



Wrist Strap Pin Securing Grub Screw

Push Buttons

The push buttons may be removed and replaced, for button replacement kits (see page 104). Each button is secured with two screws and a cover plate. To replace the buttons simply remove the two screws and refit the new button, cover plate and screws. Take care not to over tighten the screws as the rubber will compress excessively.

When removing the push buttons clean the cavity behind the button and make sure the small pressure equalization holes are also clear.



Push Button Components

20. Spares and Accessories List

Ultrasonic Probes

Part No.	Description
001-7230	Probe S2C 2.25MHz 13mm (1/2") for Cygnus DIVE <i>Probe and coiled cable, spare membranes and membrane key. Suitable for measuring metals from 3 to 250mm through coatings.</i>
001-7231	Probe S3C 3.5MHz 13mm (1/2") for Cygnus DIVE <i>Probe and coiled cable, spare membranes and membrane key. Suitable for measuring metals from 2 to 150mm through thin coatings.</i>
001-7232	Probe S5C 5MHz 13mm (1/2") for Cygnus DIVE <i>Probe and coiled cable, spare membranes and membrane key. Suitable for measuring metals from 1 to 50mm through thin coatings.</i>
001-7233	Probe S5A 5MHz 6mm (1/4") for Cygnus DIVE <i>Probe and coiled cable, spare membranes and membrane key. Suitable for measuring small tubes from 1 to 50mm through very thin coatings.</i>
001-7235	Probe T5B 5MHz 2 x 8mm for Cygnus DIVE <i>Probe and coiled cable, Suitable for measuring heavy corrosion from 1.5 to 50mm..</i>
001-7236	Probe T2C 2MHz 2 x 12mm for Cygnus DIVE <i>Probe and coiled cable, Suitable for measuring heavy corrosion, cast iron, plastics from 2.5 to 150mm.</i>

Probe Spares for S*C 13mm (1/2") Probes

Part No.	Description
001-2611	Membrane Key for 13mm 1/2" Cygnus S*C Probes
001-3701	Membranes Polyurethane 13mm 1/2" Probes Pk. of 20 max 75°C
001-4874	Membranes Teflon for 13mm 1/2" Probes Pk. of 10 max 150°C
001-3706	Membrane Couplant (25ml Bottle)
001-3709	Knurled Ring Assembly for 13mm 1/2" INOX S*C Probes

Probe Spares for S*A 6mm (1/4") Probes

Part No.	Description
001-2612	Membrane Key for 6mm 1/4" Cygnus S*A Probes
001-3702	Membranes Polyurethane 6mm 1/4" Probes Pk. of 20 max 75°C

Part No.	Description
001-4873	Membranes Teflon for 6mm ¼" Probes Pk. of 10 max 150°C
001-3706	Membrane Couplant (25ml Bottle)
001-3703	Knurled Ring Assembly for 6mm ¼" S*A Probes

Gauge Spares

Part No.	Description
001-7250	Cygnus DIVE Battery
001-7251	Battery Charger for Cygnus DIVE <i>Battery charger and mains lead</i>
001-4861	Silicone Grease for Battery (50g Tube)
001-7258	Replacement Battery Screw for Cygnus DIVE
001-7259	Replacement Push Button Kit for Cygnus DIVE
001-7253	Replacement Wrist Strap Kit for Cygnus DIVE <i>Wrist strap, pins, grub screws and Allen key</i>
001-7257	Replacement Lanyard for Cygnus DIVE
001-7271	Cygnus DIVE Direct to Computer (USB) Link Lead <i>To connect a DIVE gauge to a computer's USB port for data transfer</i>
001-7262	Umbilical (9-way D) to PC (USB) Link Lead for CygLink <i>Connects surface end of Umbilical Cable (001-7260) to a computers USB port and converts the signal from RS485 to USB. 1.8m Long</i>
001-0426	Umbilical (9-way D) to TSR Display Unit (Lemo) Link Lead <i>Connects surface end of Umbilical Cable (001-7260) to a Cygnus TSR. 1.0m Long</i>
001-7264	Cygnus DIVE Gauge to Umbilical Splice Cable <i>Connects to DIVE gauge with flying lead for splice in to customers own Umbilical Cable. 1.0m Long</i>

Accessories

Part No.	Description
001-7220	Data Logging Feature for Cygnus DIVE <i>Umbilical to computer link lead. CygLink software on USB Flash Drive. Feature Enabler on USB Flash Drive.</i>
001-7221/4	TOPSIDE REPEATER Kit for Cygnus DIVE <i>Cygnus Topside Repeater display unit, Silicone sleeve, Umbilical to TSR link lead, Cygnus DIVE to Top-Side umbilical connectors, Batteries.</i>
001-7222/4	TOPSIDE REPEATER Kit with Video OSD for Cygnus DIVE

Part No.	Description
	<i>Cygnus Topside Repeater display unit, Silicone sleeve, umbilical to TSR link lead, Cygnus DIVE to Top-Side umbilical connectors, Video cables, Power Supply.</i>
001-7223	CygLink Top Side Monitoring and Data Logging Software <i>CygLink software on USB Flash Drive. Umbilical to computer link lead & Cygnus DIVE to Top-Side umbilical connectors and data converters.</i>
001-7260	Cygnus DIVE (Fischer)-(9-way D) Topside umbilical connectors <i>Add to 001-7221/4, 001-7222/4 or 001-7223 for Cygnus supplied umbilical cable.</i>
001-0415	Umbilical cable for DIVE to Topside (per metre) <i>Specify cable length from 50m to 500m.</i>
001-7224	HelmetView Remote Display Kit for Cygnus DIVE <i>HelmetView Remote Display, Kirby Morgan Mounting Bracket</i>
001-7270	Splitter Cable for HelmetView and Surface Display

Miscellaneous Spares

Part No.	Description
001-4850	Steel Test Block 15 mm
001-4851	Steel Test Block ½"
001-4852	Coated Test Block
001-4856	Carbon Steel Step Block 5-25mm in 5mm steps set in Perspex supplied with material type and dimensional accuracy traceable certificate.

21. Technical Specifications

Cygnus DIVE Technical Specifications	
General Attributes	
Size	105 mm x 110 mm x 35 mm (W x H x D) (4.1 in x 4.3 in x 1.4 in)
Weight In Air	Complete Gauge 905 g (2 lb.) Gauge Body 557 g (1.22 lb.) Battery 79 g (0.17 lb.) Probe & Cable 269 g (0.6 lb.)
Power Supply	Rechargeable Lithium-Ion Battery
Probe Sockets	Fischer 105 Series
Operating Temperature Range	-10°C to +50°C (14°F to 122°F)
Storage Temperature Range	-10°C to +60°C (14°F to 140°F)
Battery Operation Time	Approximately 10 hrs. continuous measurement with fully charged battery pack.
Battery Voltage Range	Min 3.2 V dc, Max 4.5 V dc
Battery Type	Sealed Lithium-Ion rechargeable single cell. 8.1 Watt-hours. Internally protected against short circuit and overcharge.
Low Battery Indication	Battery Level Indication on Display with Low Battery Warning Message.
PRF	N/A
Monitor Outputs	N/A
Through Coating Measurements	Through coating measurement in Multiple Echo mode only. Coatings up to 3 mm thick as standard depending on coating velocity. Deep Coat mode provides ability to measure through thicker coatings depending on coating material.
Materials	Sound Velocity from 2000 m/s to 9000 m/s [0.0780 in/us to 0.3543 in/us]

Cygnus DIVE Technical Specifications											
Measurement Range	<p>Measurement Ranges in Steel</p> <p>Multiple Echo mode;</p> <p>S2C probe 3 to 250 mm [0.120 in. to 10.00 in.] S3C probe 2 to 150 mm [0.080 in. to 6.000 in.] S5C/A probes 1 to 50 mm [0.040 in. to 2.000 in.]</p> <p>Single Echo mode;</p> <p>T5B probe 2.0 to 100 mm [0.080 in. to 4.000 in.] T2C probe 3.0 to 150 mm [0.120 in. to 6.000 in.]</p> <p>Echo-Echo mode;</p> <p>T5B probe 4.0 to 50 mm [0.160 in. to 2.000 in.] T2C probe 6.0 to 50 mm [0.240 in. to 2.000 in.]</p>										
Accuracy	±0.1 mm (±0.004") or 0.1% of thickness measurement whichever is the greatest.										
Resolution	<table border="0"> <tr> <td>0.1 mm (0.005")</td> <td>Low Resolution Mode or measurement >99.95 mm</td> </tr> <tr> <td>0.05 mm (0.002")</td> <td>High Resolution Mode and measurement <100.0 mm</td> </tr> <tr> <td>0.01 mm (0.001")</td> <td>Single Echo Mode only and measurement <100.0 mm</td> </tr> <tr> <td>0.05 mm (0.002")</td> <td>High Resolution Mode and measurement <100.0 mm</td> </tr> <tr> <td>0.01 mm (0.0005")</td> <td>Single Echo Mode only and measurement <100.0 mm</td> </tr> </table>	0.1 mm (0.005")	Low Resolution Mode or measurement >99.95 mm	0.05 mm (0.002")	High Resolution Mode and measurement <100.0 mm	0.01 mm (0.001")	Single Echo Mode only and measurement <100.0 mm	0.05 mm (0.002")	High Resolution Mode and measurement <100.0 mm	0.01 mm (0.0005")	Single Echo Mode only and measurement <100.0 mm
0.1 mm (0.005")	Low Resolution Mode or measurement >99.95 mm										
0.05 mm (0.002")	High Resolution Mode and measurement <100.0 mm										
0.01 mm (0.001")	Single Echo Mode only and measurement <100.0 mm										
0.05 mm (0.002")	High Resolution Mode and measurement <100.0 mm										
0.01 mm (0.0005")	Single Echo Mode only and measurement <100.0 mm										
Display											
Type of Display	Colour TFT Display										
Display Size	QVGA 320 x 240 Pixels 2.8"										
Display Information	Thickness Value and A-Scan Display										
Transmitter											
Shape of Pulse	Square										
Pulse Energy : Voltage (peak-to-peak)	70 V p-p										
Pulse Energy : Rise Time	3 ns (max)										
Pulse Energy : Pulse Duration	S2C : 220 ns S3C : 100 ns S5A / S5C : 67ns T2C : 220 ns T5B : 100 ns										
Receiver											
Gain Control	Automatic Gain Control up to pre-set Maximum Gain value 120 dB dynamic range.										
Frequency Range	1.0 MHz to 10.0 MHz (-6dB)										
Other Information											

Cygnus DIVE Technical Specifications	
Data Output and Storage	RS485 2-wire duplex serial data output, 56000/115200 Baud. 32 Mbit Internal Flash Data Storage.
Data Connector	Fischer 105 Series
Calibration setting storage	Calibration Data stored to Internal Flash Memory
Calibration Mechanisms	Not required for Multiple Echo mode. Automatic V-path correction for twin crystal probes. Option of two point calibration for twin crystal probes.
Display & Recall Facilities	N/A
Display Response Time	125 ms / 500 ms
Printer Output	N/A
Environmental Rating	IP68 Rated to 300 m (984 ft) immersion in sea water MIL STD 810G Method 501.6 (High Temp +55°C) MIL STD 810G Method 502.6 (Low temp -20°C) MIL STD 810G Method 507.6 (Humidity 95%)
Shock & Impact	MIL STD 810G Method 514.7 (Vibration) MIL STD 810G Method 516.7 (Shock 20g) MIL STD 810G Method 516.7 (Transit Drop 1.22m)
Compliance	RoHS CE UKCA <i>An EU and UK Declaration of Conformity is supplied with the product kit.</i>
Designed for	BS EN 15317

The Cygnus DIVE gauge is a European Registered Community Design, No. 001947326-0001. See <http://oami.europa.eu> for more details.

22. Table of Sound Velocities

Velocities will vary according to the precise grade and processing conditions of the material being measured.



This table is included as a guide only.

Wherever possible, the Gauge should always be calibrated on the material under test.



These Velocities are given in good faith and are believed to be accurate within the limits described above.

No liability is accepted for errors.

Velocities given are the compression wave velocity c_l .

Material	Velocity of Sound (V)		Conversion Factor (f)
	m/s	in/us	
Aluminium (alloyed)	6380	0.2512	1.078
Aluminium (2014)	6320	0.2488	1.068
Aluminium (2024 T4)	6370	0.2508	1.076
Aluminium (2117 T4)	6500	0.2559	1.098
Brass (CuZn40)	4400	0.1732	0.743
Brass (Naval)	4330	0.1705	0.731
Brass (CuZn30)	4700	0.1850	0.794
Copper	4700 - 5000	0.1850 - 0.1969	0.794 - 0.845
Grey Cast Iron	4600	0.1811	0.777
Inconel	5700	0.2244	0.963
Lead	2150	0.0846	0.363
Monel	5400	0.2126	0.912
Nickel	5630	0.2217	0.951
Phosphor Bronze	3530	0.1390	0.596
Mild Steel	5920	0.2331	1.000
Tool Steel	5870	0.2311	0.992
Stainless Steel 302	5660	0.2228	0.956
Stainless Steel 347	5790	0.2279	0.978
Stainless Steel 314	5715	0.2250	0.965

Material	Velocity of Sound (V)		Conversion Factor (f)
	m/s	in/us	
Stainless Steel 316	5750	0.2264	0.971
F51 Duplex Steel UNS S31803	5715 - 5750	0.225 - 0.2264	0.956 - 0.971
Core Ten Steel EN12223 S355-J0	5920	0.2331	1.00
Tin	3320	0.1307	0.561
Titanium	6100 - 6230	0.2402 - 0.2453	1.030 - 1.052
Tungsten Carbide	6660	0.2622	1.125
Epoxy Resin	2500	0.0986	0.422
Acrylic	2730	0.1076	0.461
Nylon (Polyamide)	2620	0.1032	0.443

Reading Conversions

If only a few measurements are to be taken on a material other than Steel, it may be easier to leave the calibration set for Steel and merely convert the readings by multiplying by the **Conversion Factor** for the material being measured. This method avoids unnecessary recalibration.

Example.

The gauge is calibrated for Steel [5920 m/s], but the reading is being taken on Copper [4700 m/s] :

$$\begin{aligned}
 T &= t \times V_{\text{COPPER}} / V_{\text{STEEL}} \\
 &= t \times 4700 / 5920 \\
 &= \underline{t \times 0.794}
 \end{aligned}$$

thus : **$T = t \times f$** [where: $f = V_{\text{COPPER}} / V_{\text{STEEL}}$]

where : **T = true thickness of Copper being measured**

t = actual reading obtained

f = Conversion Factor (from table)

V_{COPPER} = Sound Velocity in Copper : 4700 m/s

V_{STEEL} = Sound Velocity in Steel : 5920 m/s

The **Conversion Factor f**: is given for various materials in the Table of Sound Velocities

23. Recycling and Disposal (EC Countries)

The WEEE Directive (Waste Electrical and Electronic Equipment 2002/96.EC) has been put into place to ensure that products are recycled using best available treatment, recovery and recycling techniques to ensure human health and high environmental protection.

The gauge has been designed and manufactured with high quality materials and components which can be recycled and reused. It may contain hazardous substances that could impact health and the environment. In order to avoid the dissemination of those substances in our environment and to diminish the pressure on natural resources we encourage you to dispose of this product correctly.



DO NOT dispose of this product with general household waste.

DO dispose of the complete product including cables, plugs and accessories in the designed WEEE collection facilities.



This product may also be returned to the agent or manufacturer who supplied it for safe end-of-life disposal.

24. Shipping of Lithium-Ion Batteries

The DIVE battery pack contains a single rechargeable Lithium-Ion cell UN reference number **UN 3481 PI 966 Section II**.

The DIVE battery complies with the UN Manual of Tests and Criteria, Part III, subsection 38.3.

For shipping they must be packaged as set out in IATA Packaging Instructions 966.

-  **Faulty batteries MUST NOT be shipped back to Cygnus Instruments, their agent or distributor.**
-  **It is forbidden to transport faulty or damaged lithium batteries, they must be correctly disposed of locally.**

Battery Information

The Watt-hour rating of the battery is 8.1 Watt-hour

Composition;

Steel, Copper Aluminium	31%
Polypropylene	10%
Lithium cobaltite	29%
Organic solvents	13%
Salts	1%
Lithium metal	0%

Electrochemistry;

Negative electrode	carbon
Positive electrode	Lithium cobaltite
Electrolyte	Solution of lithium hexafluorophosphate in a mixture of organic solvents
Nominal battery voltage	3.7 V
The battery contains less than 0.5g Lithium	

25. Warranty Information

LIMITED THREE YEAR WARRANTY FOR CYGNUS ULTRASONIC THICKNESS GAUGES

1. Cygnus Instruments Limited ("CYGNUS") warrants that, subject as set out below, the Products manufactured by it (excluding consumables, batteries, probes, leads, microphones and telescopic extensions) will be free from defects in materials and workmanship for a period of three years from the date of purchase either from CYGNUS or from an Authorised CYGNUS Distributor. Batteries, probes, leads, microphones and telescopic extensions are warranted for 6 months. This warranty is limited to the original Purchaser of the Product and is not transferable. During the warranty period, CYGNUS will repair, replace or refund, at its option, any defective Products at no additional charge, provided that the product is returned by the original Purchaser, shipping prepaid, to CYGNUS or an Authorised CYGNUS Distributor. If shipped by mail or any common carrier, the Purchaser must insure and accept all liability for loss or damage to the Product and must use shipping containers equivalent to the original packaging. Replacement products or parts will be furnished on an exchange basis only. All replaced products or parts become the property of CYGNUS.
2. Any defects in materials or workmanship must be notified to CYGNUS by the Purchaser within seven days after the discovery of the defect or failure.
3. Dated proof of purchase must be provided by the Purchaser when requesting warranty work to be performed or making any other claim under this warranty. CYGNUS will not be liable under this warranty unless the total price for the Product was paid by the due date for payment.
4. This warranty does not extend to any products which have been damaged as a result of, accident, misuse or abuse, natural or personal disaster, service, modification or repair by anyone other than CYGNUS or an Authorised CYGNUS Service Centre, failure to properly store or maintain the Product, negligence, abnormal working conditions, fair wear and tear, or failure to follow the instructions issued by CYGNUS in relation to the Product.
5. Except as expressly set forth above or in the CYGNUS Terms of Sale, subject to which the Products were purchased, all warranties, conditions or other terms implied by Statute or Common Law are extended to the fullest extent permitted by law.
6. Except in respect of death or personal injury caused by the negligence of Cygnus, Cygnus shall not be liable to the Purchaser or to any other person by reason of any representation (unless fraudulent), or any implied warranty, condition or other term, or any duty at common law, or under the express terms of the contract for purchase of the Products, for loss of profit or for any indirect, special or consequential loss or damage, costs, expenses or other claims for compensation whatsoever (whether caused by the negligence of Cygnus, its employees or agents or otherwise) which arise out of or in connection with the supply of the Products or their use or resale by the Purchaser or by any other person. The entire liability of Cygnus under or in connection with the Products shall not exceed the price paid for the Products, except as expressly provided in this warranty.

26. Pressure Test Statement

All Cygnus DIVE gauges are pressure tested in water as part of our test procedures.

Please refer to the environmental rating section for further information

27. Connection Diagram: Umbilical Cable

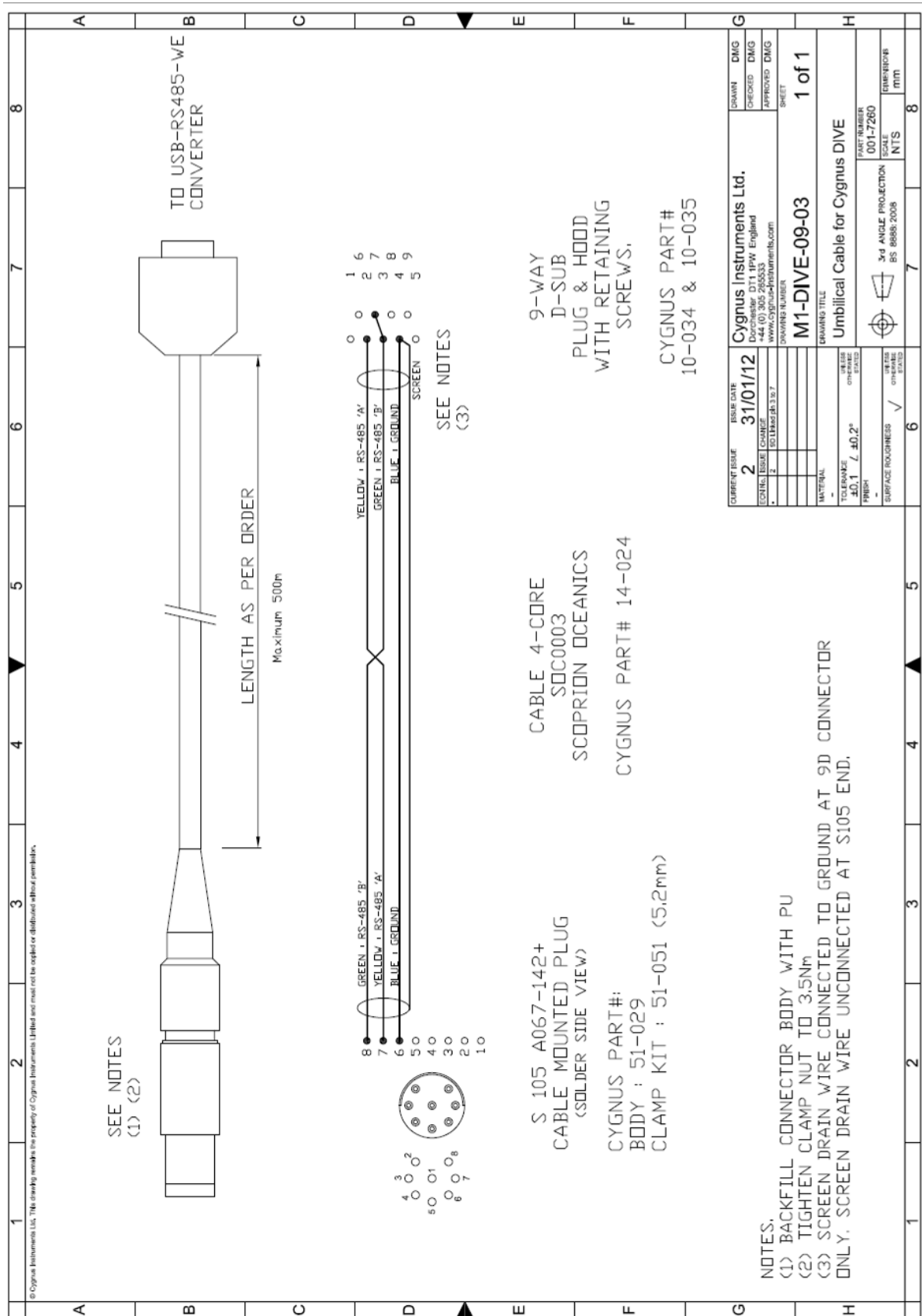

28. Connection Diagram: Umbilical to TSR

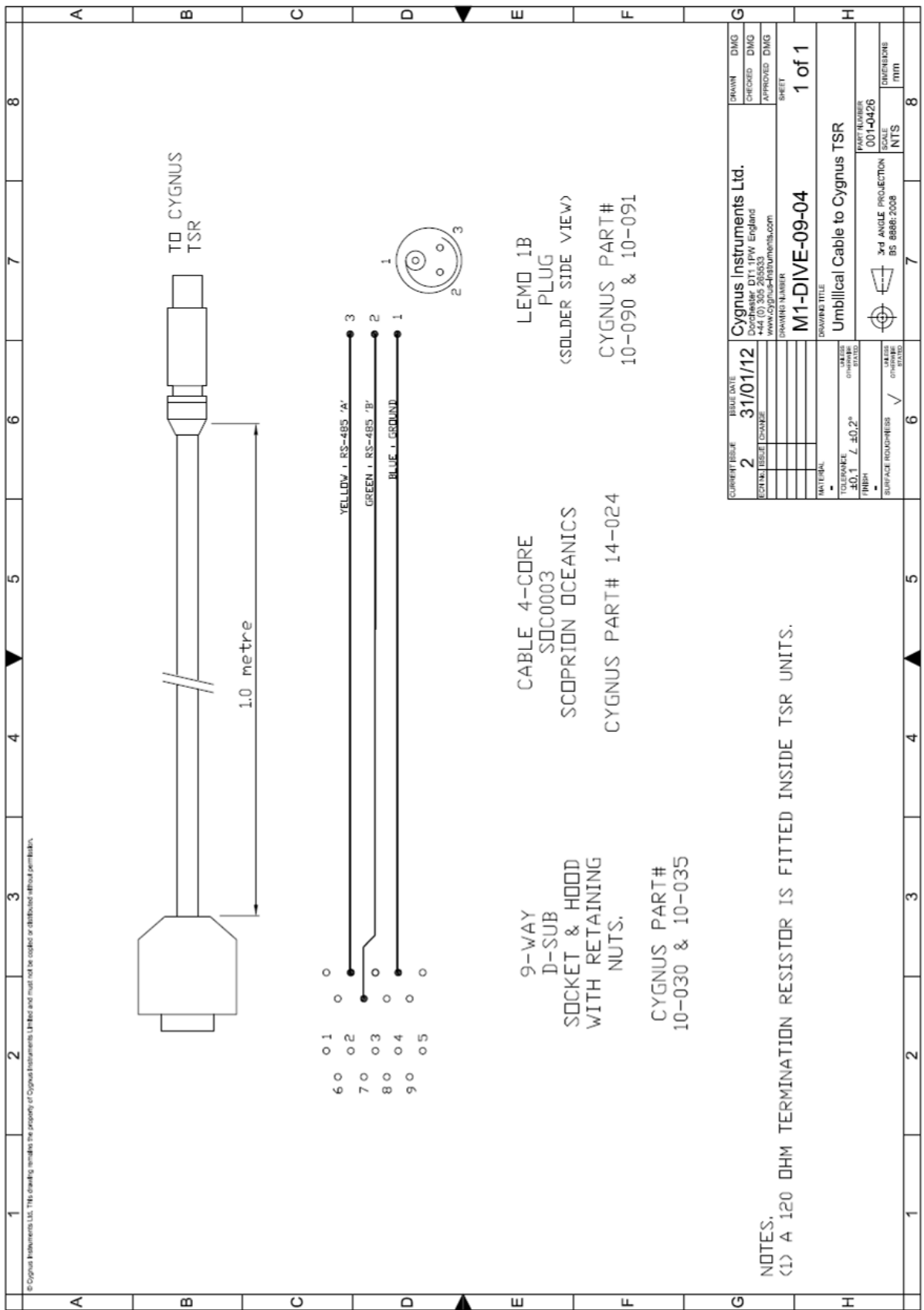

29. Connection Diagram: DIVE to Umbilical

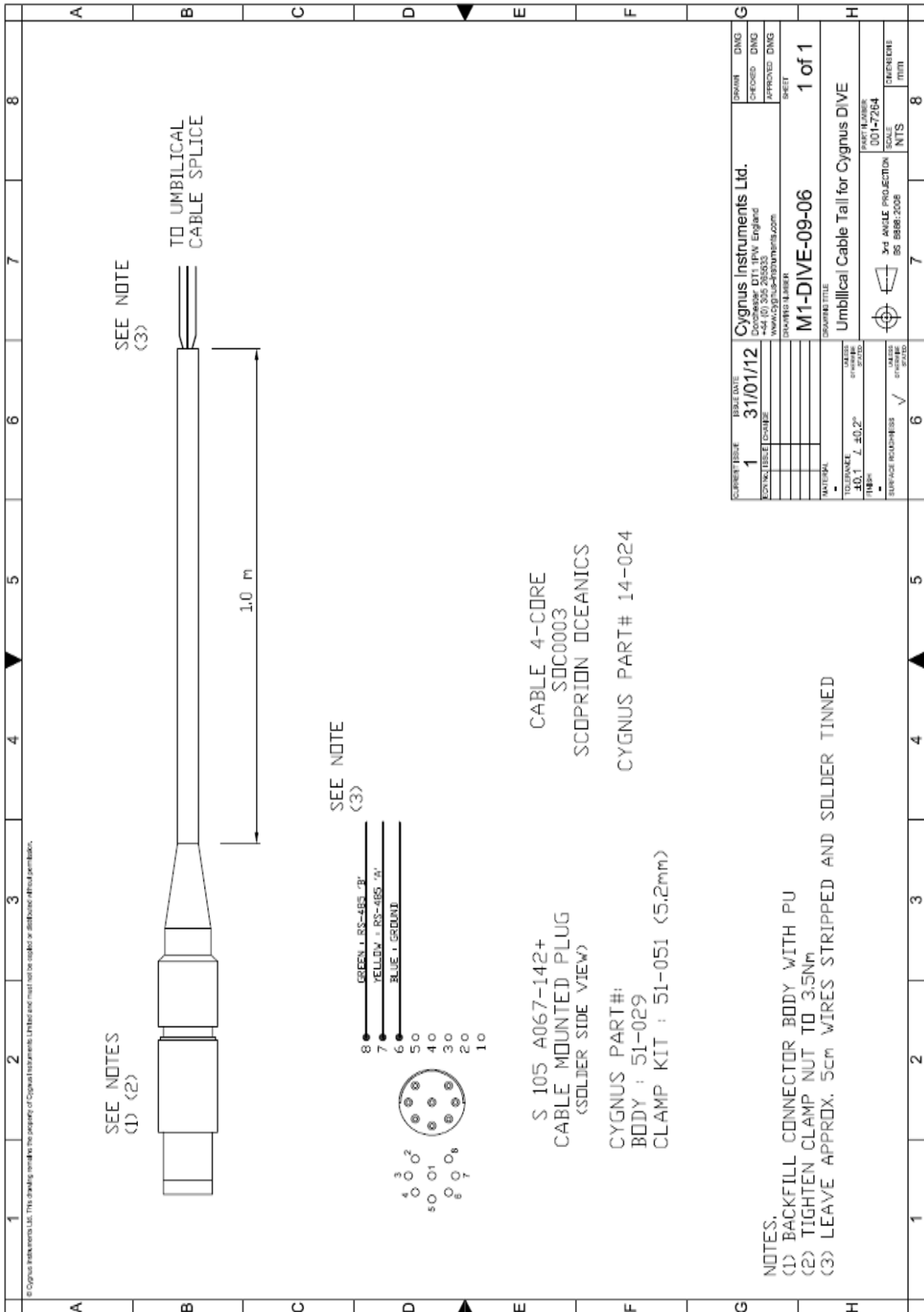

30. Index

- A-Scan
 - Backwall Echo, 42, 46
 - Pits & Flaws, 43
- A-Scan Display
 - Range, 54
 - Turning On/Off, 55
- Battery
 - Charge Time, 15
 - Charging, 15
 - Fitting, 13
 - Low Battery, 36
 - Rating, 110
 - Removal, 14
 - Shipping, 13, 98, 99, 110
- Buttons, 50
- Calibration
 - Conversion Factor, 108
 - Known Thickness, 56
 - Ladder Step Wedge, 57
 - Lock, 65
 - Material List, 61
 - Two Point Calibration, 57
 - Velocity, 55
- Cleaning, 98
- CygLink
 - COM Port, 82
 - Comment List, 92
 - Comments, 93
 - Cursors, 87
 - Drivers, 83
 - Gauge Settings, 86
 - Installation, 81
 - Logging, 91, 92
 - Material Table, 86
 - PDF, 90
 - Requirements, 81
- Datalogging
 - AutoLog, 66
 - AutoLog RELEASE, 71
 - Capacity, 66
 - Clearing Memory, 70
 - Grouping, 67
 - Groups, 69
 - Stop, 68
- Deep Coat, 63
- Disposal, 109
- Echo-Echo, 29
- HelmetView
 - Bracket, 72
- Ignore Coatings, 28
- Menu Diagram, 53
- Menus, 50
- Multiple Echo, 28
 - Echo Bars, 40
 - Parallel, 97
 - Rough Surfaces, 97
- Mutiple Echo
 - Resolution, 62
- Power Save, 64
- Probe Settings, 51
- Probe Type, 64
- Probes
 - Connection, 16
 - Heavy Corrosion, 20
 - Knurled Ring, 26
 - Membrane Couplant, 26
 - Membrane Key, 26
 - Polyurethane Membrane
 - Membrane, 25
 - Securing, 18
 - Single Element, 19
 - Twin Element, 20

Wear Indication, 27
Problems, 99
Recycling, 109
Repair, 99
Serial Number, 32
Service, 99
Setup Screens, 51
Single Echo, 28
 Resolution, 62
Software Version, 32
Sound Velocities, 107
Specifications, 107
Surface Preparation, 37
 loose rust, 38

Thickness Measurement, 39
Through Coating, 28
Topside Repeater
 Automatic Display Backlight,
 75
 Batteries, 76
 Display Units, 75
 HOLD, 75
 LCD display, 74
 OSD Position, 77
 Video Signal, 77
Units of Measure, 62
Warranty, 111
WEEE Directive, 109