

Cygnus UNDERWATER and Topside Repeater Systems

Operation Manual and Accessories List

Doc No. M4-CYG1UW-TSR-M-ENG_Iss12.docx
February 2022
(Mk4 Cygnus UW Gauges)

Contents

1. Important Notice	6
2. Introduction.....	7
Cygnus UNDERWATER (UW) Thickness Gauge.....	7
Multiple Echo Measurements	9
Triple Echo Verification	9
Cygnus Instruments.....	11
Gauge Kit Contents	12
Basic Kit Contents: "Cygnus UNDERWATER Upgradable Kit"	12
Upgrade Kit 'A' – Cygnus Topside Repeater (TSR) Display	13
Upgrade Kit 'B' – CygLink Software	14
3. Gauge Preparation	15
Fitting the Battery Pack	15
Connecting the Probe and Nosecone	16
Removing the Nosecone.....	16
Replacing the O-Ring Seals	17
Checking the O-rings.....	19
Lanyard	20
4. Gauge Operation	21
Gauge Controls	21
Turning the Gauge On	22
Turning the Gauge Off.....	22
Automatic Power Off.....	22
Taking a Thickness Measurement	23
Echo-Strength Indicators	23
Battery Life.....	25
Low Battery Warning.....	25
Charging the Batteries.....	26
5. Topside Repeater Facility	28
6. Using the Topside Repeater Display	29
Turning the Unit On	29
Turning the Unit Off	30
Changing the Displayed Units	30
Display Hold Function.....	30
Automatic Display Backlight	30
Connecting to the Cygnus UNDERWATER Gauge	30
Testing the Link.....	31
Troubleshooting - Error Messages	32

7. CygLink Surface Display and Control Kit	33
Kit Contents.....	33
Connection Diagram.....	34
Connector Details and Signals	34
Installing CygLink	34
Requirements.....	34
Upgrading.....	35
Installing	35
Running CygLink Application.....	35
Connecting to the Gauge	35
First time USB Connection	35
COM Port Numbers.....	35
Connecting the Gauge to CygLink for the First Time	36
Connecting to the Gauge Afterwards	36
Disconnecting from the Gauge	37
Manual Connection Settings.....	37
Status Bar	37
Surveys	38
Creating a new Survey.....	38
Opening an Existing Survey	39
Editing the Survey Info	39
Managing the Survey	40
Sorting Survey Records	40
Viewing Record Information.....	40
Ref and Min Thickness	41
Protection State.....	42
Measurement Summary Stats	42
Logging Measurements in CygLink.....	43
Logging Measurements	43
Grouping Measurements in Survey Records.....	43
Viewing Thickness Measurements in a Record.....	43
Managing Measurements.....	44
Viewing Measurement Information.....	45
Adding Comments to Measurements	46
Measurement Comment List	47
Creating a PDF Survey Report	48
Exporting a Survey to a CSV File.....	50
CygLink Trouble Shooting	51
Setting the COM Port Manually	51
Finding your COM Port Number	51

To Change the COM Port number assigned by Windows® 52

 Opening Device Manager..... 52

 Connection Problems – USB Drivers 55

 Wiring Problems 55

8. Connecting the UNDERWATER Gauge to the Computer ... 56

9. Probes & Membranes 57

 Probe Selection 57

 Changing the Membrane 58

 Probe Selection & Specifications..... 59

 Probe Frequency Identification..... 59

10. Gauge Setup 60

 Gauge Menu Diagram..... 60

 Connecting the Battery during Setup 61

11. Calibrating the Gauge 62

 Calibrating to a known thickness (Single Point)..... 63

 Setting the Velocity of Sound..... 64

 Measurement Units 65

 Resolution Setting 66

 Automatic Probe Frequency Setting 67

12. General Points on Thickness Gauging 68

13. Troubleshooting..... 69

 The Gauge will not Switch On 69

 Difficulty obtaining a Reading 69

 If Readings are Erratic or Unstable 69

14. The 4 Point Check 71

15. Care and Servicing 72

 Cleaning the Gauge..... 72

 O-Ring Seals..... 72

 Batteries 72

 Environmental..... 72

 Repairs 73

 Returning the Gauge for Servicing..... 73

16. Information 74

 Technical Specifications 74

17. Topside Repeater Electrical Connections 76

 Cygnus UNDERWATER Gauge to Topside Repeater Display Unit 76

 Cygnus UNDERWATER Gauge to USB-485 to Computer (CygLink)
 76

18. Serial Data Format	77
Protocol.....	77
19. Table of Sound Velocities	80
Reading Conversions	81
20. Accessories List	82
Cygnus UNDERWATER Probes with 1 metre Lead	82
Probe Spares and Membranes.....	82
Cables and Leads.....	83
Electronic Bodies Only	83
Batteries and Chargers	84
Miscellaneous Spares	84
Carry Case	84
21. Topside Repeater Upgrade Options	85
Add Option A or B to a Cygnus UNDERWATER Gauge with Impulse Socket	85
22. Recycling and Disposal (EC Countries)	87
23. Warranty Information	88
24. Pressure Test Statement	89
25. Index	90

1. Important Notice



This following important information must be read and understood by all users of Cygnus ultrasonic thickness gauges.

The correct use of Cygnus ultrasonic thickness gauges requires identification of the correct equipment for the specific application coupled with an appropriately trained and qualified operator or technician. The incorrect use of this equipment, along with its incorrect calibration, can result in serious financial loss due to damage to components, facilities, personal injury and even death.

Neither Cygnus Instruments nor any of its employees or representatives can be held responsible for improper use of this equipment. Proper training, a complete understanding of ultrasonic wave propagation, thorough reading of this manual, proper transducer selection, correct zeroing of the transducer, correct sound velocity, correct use of the appropriate test blocks, proper cable length and proper couplant selection all play a factor in successful ultrasonic thickness gauging. Of critical importance is the process of complete and accurate calibration of the instrument.

This manual will provide instructions in the set up and operation of the thickness gauge. Additional factors that can affect the use of ultrasonic equipment are beyond the scope of this manual and to that end it is understood that the operator of this equipment is a well-trained inspector qualified by either their own organisation or another outside agency to the appropriate level of both theory and practical application of ultrasonics.

Therefore Cygnus Instruments recommends that users of its ultrasonic thickness gauges should be formally qualified to a minimum of UT "Level 1" (ASNT or PCN) which will provide approximately 40 hours of training.

2. Introduction

Cygnus UNDERWATER (UW) Thickness Gauge

The Cygnus UNDERWATER Thickness Gauge is a rugged, handheld, battery-powered instrument designed for high-reliability ultrasonic thickness measurement using the multiple-echo technique.

The Cygnus UNDERWATER Thickness Gauge is a fully waterproof unit designed for use by professional divers. It is pressure rated and tested to a depth of 300 metres (984 ft). The gauge is powered by a rechargeable NiMH battery pack.

Measurements can be displayed in Metric (mm) or Imperial (inch) units; measurement resolution can be selected for either 0.1 mm or 0.05 mm, (0.005 inch or 0.002 inch). The Gauge has a side-mounted red LED display which can easily be read in low-light situations.

Crystal-controlled Calibration provides stability and accuracy. The gauge can easily be calibrated to a known thickness or to a known Velocity of Sound. Velocity of Sound is displayed in either m/s or in/ μ s, depending on the current selection for Measurement Units.

The Top-Side Repeater (TSR) facility allows the thickness measurements to be relayed from the Gauge up to the surface where they can be observed and recorded. The TSR equipment is either included with a new Gauge or can be added to the kit later¹ as an accessory.

The Gauge is able to operate accurately in adverse environmental conditions.



The Gauge is a solid-state electronic instrument which, under normal operating conditions, will give many years of active service.

¹ To connect the TSR the Cygnus UW gauge must have an integral Impulse Connector fitted.

Although designed for ease of operation first time users should carefully read this manual to familiarise themselves with the features of the Gauge

Multiple Echo Measurements

The Gauge works on the pulse-echo principle. The Probe transmits a very short pulse of ultrasound which enters the test piece. The Probe then acts as a receiver listening for return echoes, converting them into electrical signals which are processed to produce timing information that can be used to determine the material thickness.

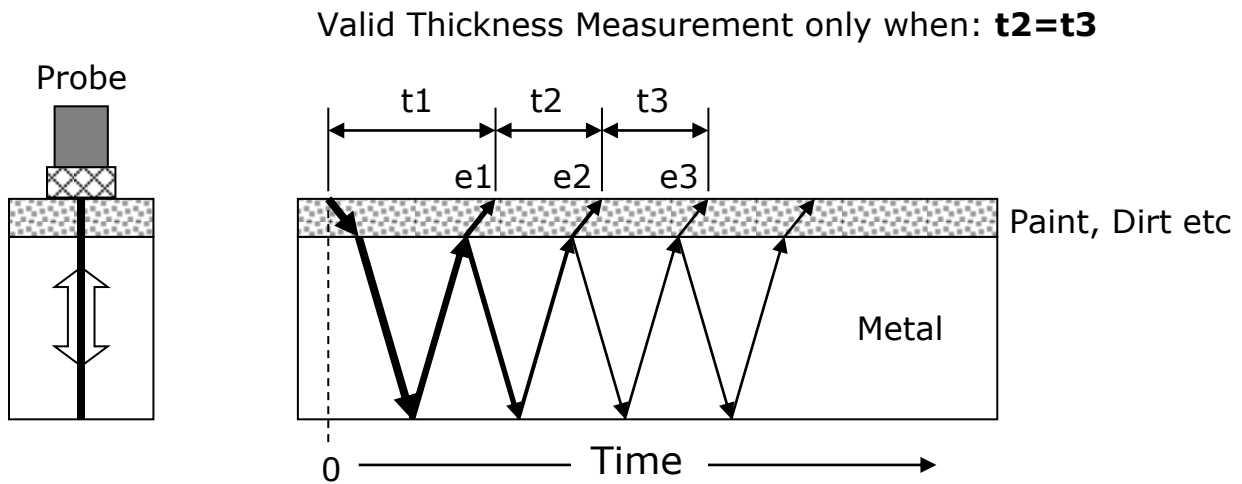

The *multiple-echo* beam travel is depicted above, spread out in time, to illustrate the timing method. In reality the beam path is straight and perpendicular to the surface as the ultrasonic energy reverberates up and down within the metal (shown on the left). Each time an echo is reflected back down, a small portion of the energy comes up through the coatings (e_1 , e_2 and e_3) and is detected by the Probe which acts as a receiver.

The delay between echoes at the Probe-face (t_2 and t_3) is exactly equal to the time taken to pass through the metal twice, therefore coatings such as paint are ignored and the measurement displayed is the metal thickness only.

Triple Echo Verification

The Gauge requires 3 equi-spaced return echoes in order to calculate a thickness measurement value ($t_2=t_3$). This method ensures the Gauge only displays valid thickness values, the three

echoes provide a reliable method of signal verification. This process is referred to as Triple Echo Verification.

Cygnus Instruments

Cygnus Instruments Limited, founded in 1983, pioneered the development of the Digital *Ultrasonic Multiple-Echo Technique* used for measurement through coatings. This has long since been the standard required to ensure that accurate measurements are taken without the need to zero the Gauge or remove any coatings first.

Our philosophy is to work closely our customers to provide high quality products, engineered to serve heavy industry & harsh environments. Cygnus Ultrasonic thickness gauges are designed to be reliable and simple to use. We have an unrivalled reputation in over 45 countries around the world.



CYGNUS Instruments Ltd.

Cygnus House, 30 Prince of Wales Road,
Dorchester, Dorset, DT1 1PW England.
Website: www.cygnus-instruments.com
Tel: 00 44 (0) 1305 265533
Fax: 00 44 (0) 1305 269960
sales@cygnus-instruments.com

Cygnus UAE Cygnus Instruments Middle East

P.O. Box 127267
Jebel Ali Free Zone (JAFZA)
Dubai
UAE
Website: www.cygnus-instruments.com
Telephone: +971 50 3459305
E-mail: sales@cygnus-instruments.com

CYGNUS Instruments Inc.

Phillips Hwy Commerce Park
6900 Phillips Hwy, Suite 8
Jacksonville, FL 32216
Tel: 00 1 410 267 9771
Fax: 00 1 410 268 2013
www.cygnusinstruments.com
sales@cygnusinstruments.com

CYGNUS Singapore (S) Pty. Ltd.

63 Jalan Pemimpin #05-01,
Pemimpin Industrial Building.
577219 Singapore.
Tel : (+65) 6252 5909
Fax : (+65) 6251 1318
www.cygnus-instruments.sg
sales@cygnus-instruments.sg

Gauge Kit Contents

Basic Kit Contents: "Cygnus UNDERWATER Upgradable Kit"



1. Cygnus UNDERWATER Gauge Body
2. Lanyard & silicone grease & Tommy Bar
3. Two Rechargeable NiMH Battery Packs
4. Battery Charger and Leads
5. Probe for Cygnus UNDERWATER, supplied as nosecone assembly with 1 m cable
6. Membrane Couplant
7. Accessories: Spare O-Rings, Spare Membranes, Membrane Locking Ring Key, 15 mm (1/2") Test block, Torque ("Tommy") bar & Calibration Jumper Lead

The Operating Manual and Documentation is attached in the lid of the case.

Upgrade Kit 'A' – Cygnus Topside Repeater (TSR) Display

In addition to the main kit the following items are included:



1. Cygnus Topside Repeater Display unit
2. Umbilical cable:
 - a. Impulse connector for Gauge connection
 - b. Lemo connection for Topside Repeater Display unit

Upgrade Kit 'B' – CygLink Software

In addition to the main kit the following items are included:



1. CygLink Software & Driver Installation CD or USB flash drive
2. Umbilical cable
3. USB-485 Converter

3. Gauge Preparation

The battery packs are supplied uncharged therefore both will require a full charge before use (see 'Charging the Batteries' on page 26).

Once the batteries have been charged the Gauge is ready for use. Just fit a battery pack, screw on the nosecone/probe assembly, turn on the power and you are ready to take thickness measurements.

Fitting the Battery Pack

The Gauge is supplied with two rechargeable NiMH battery packs which are screwed onto the gauge body by hand. Do not over-tighten the battery packs – hand tight is sufficient.

When the battery pack is correctly fitted there should be no gap between the battery pack and gauge body.



Correctly Fitted



Incorrectly Fitted



When changing the battery it is advisable to check the O-rings (page 19) and if necessary fit two new O-ring seals to the gauge body. See 'Replacing the O-Ring Seals' on page 17.

Connecting the Probe and Nosecone

The Probe is connected to the nosecone via a length of underwater coaxial cable, the nosecone then screws on to the end of the Gauge body.

When screwing the nosecone onto the Gauge body tighten only by hand, ensuring there is no gap between the nosecone and Gauge.

! DO NOT use the Tommy Bar to tighten the nosecone.



Correctly Fitted

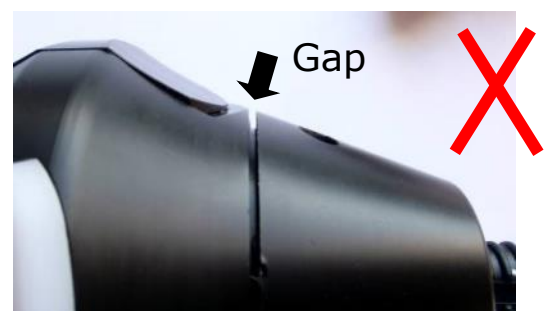

Incorrectly Fitted

Removing the Nosecone

The nosecone can be difficult to remove when the O-rings have been compressed so a Tommy Bar is supplied with the kit to allow extra leverage to be applied to 'break' the seal. Fit the Tommy Bar into the hole in the nosecone then unscrew using the Tommy Bar as a lever.



Replacing the O-Ring Seals

There are four O-ring seals fitted to the Gauge body, two for the battery and two for the nosecone. Spare O-rings are included in the kit, the different O-rings are marked A, B, C & D (B and D are the same).

 <p>'O' - RINGS 'A' SEE MANUAL FOR CORRECT LOCATION</p>	 <p>'O' - RINGS 'B/D' SEE MANUAL FOR CORRECT LOCATION</p>	 <p>'O' - RINGS 'C' SEE MANUAL FOR CORRECT LOCATION</p>
<p>'A' O-rings (1 pack of 10)</p>	<p>'B/D' O-rings (2 packs of 10)</p>	<p>'C' O-rings (1 pack of 10)</p>

1. Remove the old O-rings and destroy them
Do not use a sharp instrument to remove the O-rings as damage to the sealing area may occur
2. Clean the O-ring locations removing all grease and dirt
3. Pre-lubricate the new O-rings with silicone grease
4. Gently fit the new O-rings into position

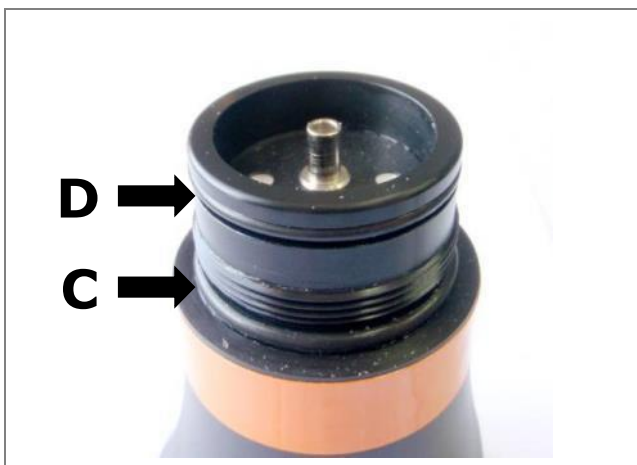

Battery-End O-ring Location

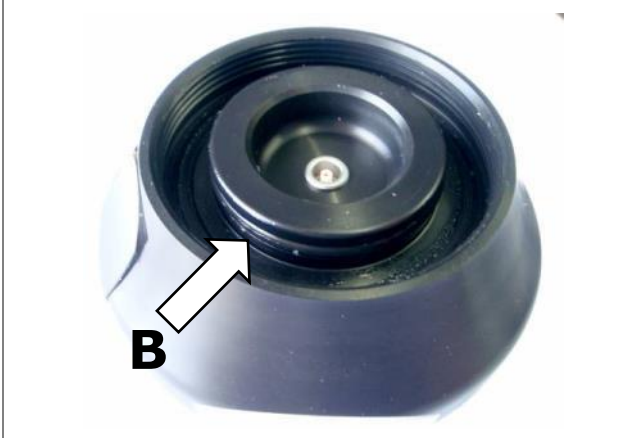

Nosecone O-ring Location

Gauge (Nosecone-End) O-ring Location

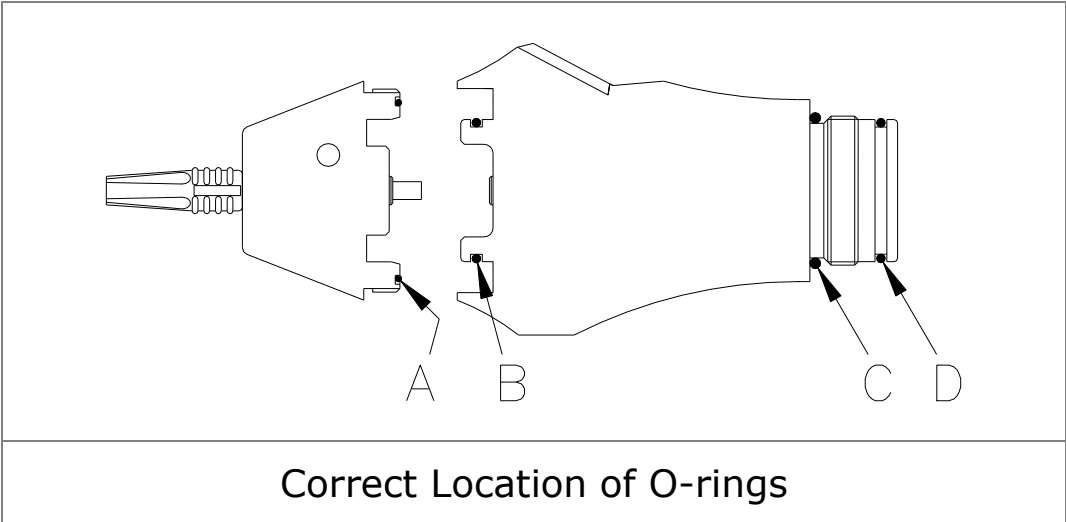

Be careful not to fit the 'A' O-ring in the wrong position, this is a common mistake that will cause incorrect gauge operation.

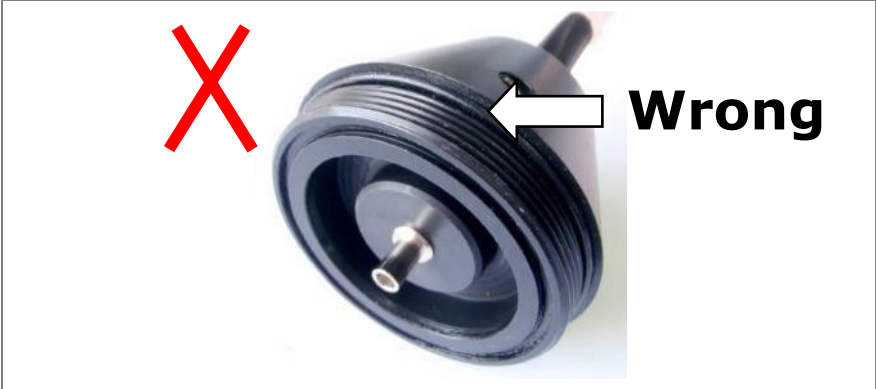

Incorrect Location of Nosecone 'A' O-ring

Checking the O-rings

To ensure the gauge remains water-tight these O-rings must be checked each time you remove the battery pack or nosecone. It is recommended to replace the O-rings if in any doubt as to their condition or age.

- ✓ Replace the O-rings at the start of a new job
- ✓ Replace the O-rings after every 2-3 dives
- ✓ Check the O-rings whenever you remove the battery
- ✓ Check the O-rings whenever you remove the nosecone
- ✓ Always lubricate the O-rings with silicone grease
- ✗ Do not use old or damaged O-rings
- ✗ Never use the Gauge without any O-rings fitted

Spare O-rings are included in the Kit and can be ordered from Cygnus Instruments (see page 11 for contact details).

Things to look for when inspecting the O-rings are:

- Any flats or signs of wear
- Any signs of pinching or trapping
- Any sand or dirt in the silicone grease
- Any cuts or cracks

Lanyard

A lanyard is supplied with the kit for attaching the assembled gauge to a diver's belt. The small screw-locking gate should be attached to the battery pack D-ring; the other two larger carabiners can then be attached to a belt. One has a screw-gate for secure attachment to a belt, the other a snap-gate for quick repositioning of the gauge during use.

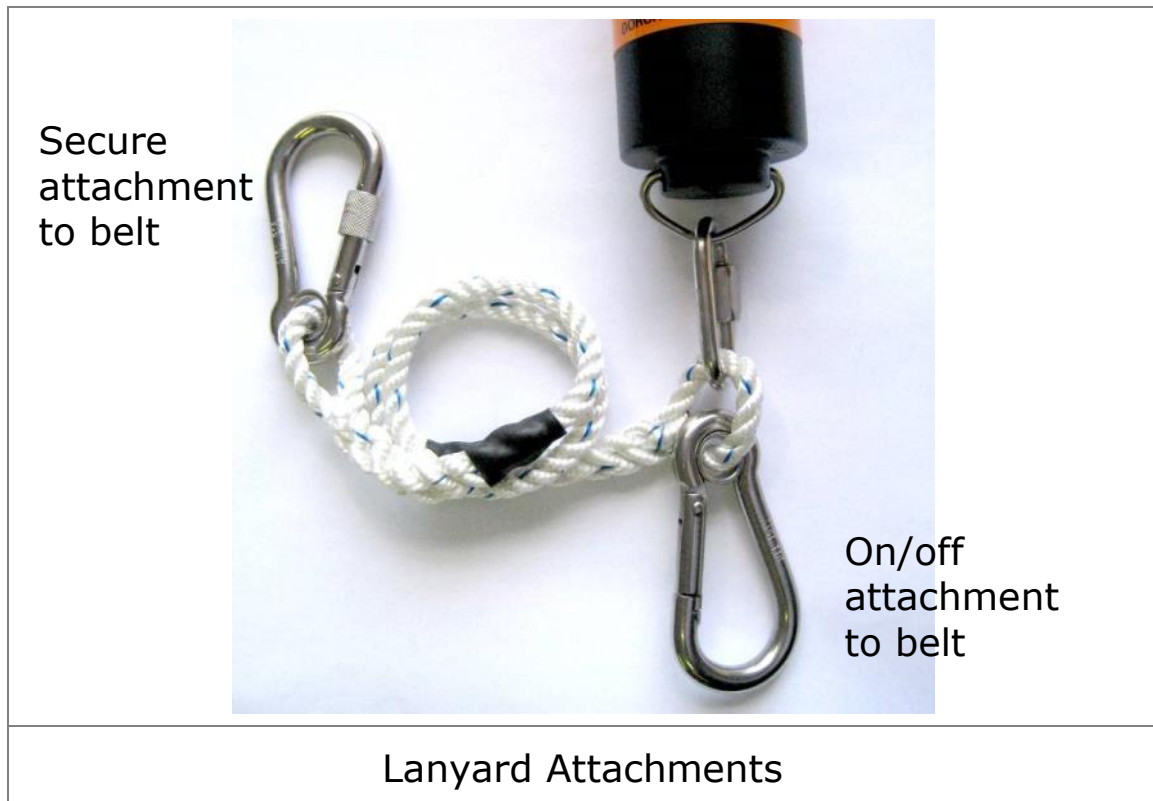





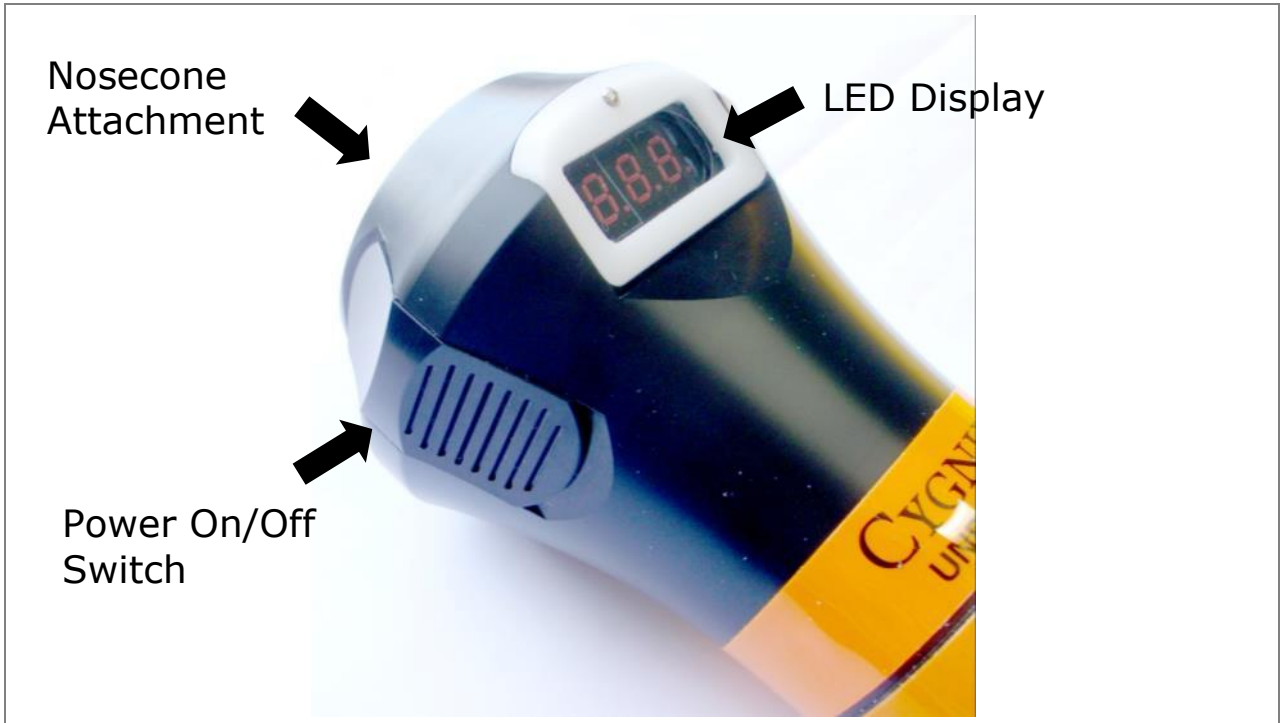

4. Gauge Operation

Gauge Controls



Turning the Gauge On

1.	Press the Power button forward	
2.	The display test '8888' appears	
3.	The firmware version is displayed	
4.	The hardware version is displayed	
5.	The probe frequency is displayed	
6.	The velocity of sound is displayed	
7.	The Gauge type is displayed	
8.	The Gauge is ready to use	



Turning the Gauge Off

1.	Press the Power button forward briefly	
2.	The display scrolls 'shutoff' and the Gauge turns off	

Automatic Power Off

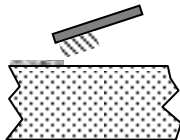
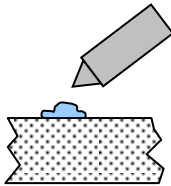
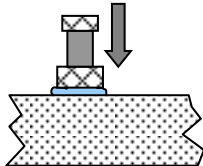

The Gauge will turn off automatically 5 minutes after the last thickness measurement was taken.

Taking a Thickness Measurement

<p>1.</p>	<p>Remove any marine growth, loose rust, dirt or loose coatings and brush the test area clean</p>	
<p>2a</p>	<p>When measuring underwater there is no need to use a couplant - the water itself will act as a couplant</p>	
<p>2b</p>	<p>When measuring in air apply couplant to the test surface</p>	
<p>3.</p>	<p>Place the probe-face on the prepared, test surface and make firm contact applying gentle pressure</p>	
<p>4.</p>	<p>The Gauge will display a thickness measurement or an indication of Echo Strength if no valid measurement has been found</p>	

Echo-Strength Indicators

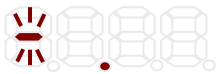
Should the Gauge be unable to detect a stable multiple echo signal it displays an Echo Strength indication to help the operator locate a suitable position.

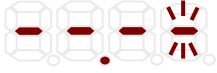
<p>1.</p>	<p>1 Bar Flashing: No echoes detected</p>	
<p>2.</p>	<p>1 steady + 1 Bar Flashing: Only 1 echo detected</p>	
<p>3.</p>	<p>2 steady + 1 Bar Flashing: Only 2 echoes detected</p>	
<p>4.</p>	<p>3 steady + 1 Bar Flashing: 3 echoes detected but they are not related</p>	

To help obtain a multiple echo reading the operator should continue to move the probe around to locate a suitable reflector, using a slight rocking motion.

Note: When using the gauge underwater the ultrasound will travel through the water and can get reflected back to the gauge by nearby surfaces causing the echo strength bars to increase - this is normal.

Battery Life

The Gauge will operate continuously for approximately 20 hours when fitted with a fully charged battery pack. It is recommended that you always fit a recharged battery pack at the start of each dive session.

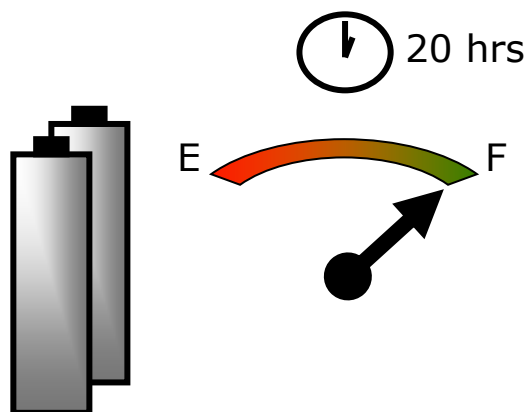

Low Battery Warning

The Gauge will periodically flash a Low Battery warning message when the batteries are getting low. You may still be able to continue taking measurements for about 1/2 hour.

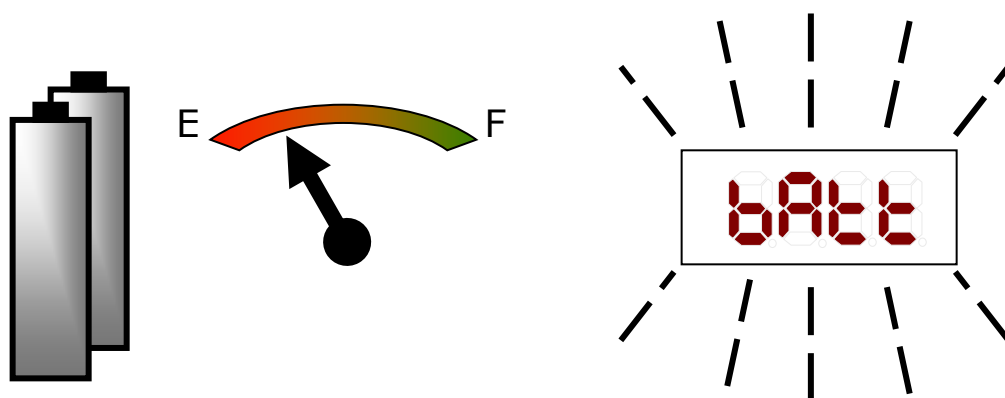

When the batteries are discharged the Gauge will flash the low battery warning for 5 seconds then turn of automatically.

Charging the Batteries

The batteries must only be charged using the charger supplied with the kit. The normal charge time is about 2 hours but this will depend on the battery charge state. As the batteries use NiMH cells there is no need to discharge the cells before charging, the batteries can be 'topped up' after use.

To charge the batteries simply connect the battery to the charger then plug in and turn on the power. The charger requires an AC power source of 100 to 240 V AC, 50 to 60 Hz, 0.35 A.

There is a charge indicator lamp on the top of the charger to show the state of the charge cycle.

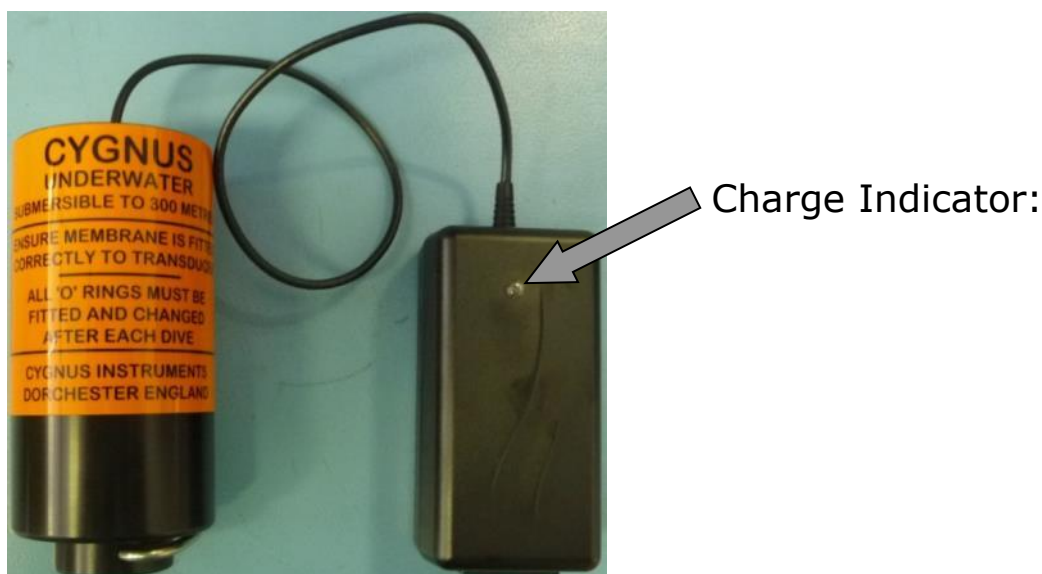

Charge Indicator	Meaning
Yellow	Battery Pre-charge Analysis
Orange	Fast Charge
Green / Yellow	Top-up Charge
Green	Trickle Charge
Orange / Green	Battery Error



The charger is designed for indoor use only and should not be exposed to water or dust.

5. Topside Repeater Facility

The Topside Repeater (TSR) facility allows the thickness measurements to be relayed from the Gauge up to the surface where they can be observed and recorded. The TSR equipment is either included with a new Gauge or can be added to the kit later² as an accessory.

There are three ways of displaying the thickness measurements topside;

1. Using a Cygnus Topside Repeater Display (Option A)
2. Using a computer with CygLink software (Option B)
3. Using both of the above (Option C)

Option C uses a special 'Y' splitter cable.

To get the thickness measurements topside the gauge sends packets of serial data using an RS-422 interface. The RS-422 is a simplex differential signal transmitted along a single twisted pair. The maximum cable length is 1,200 metres (4,000 ft).

It is possible for a third party application to read the data packets and process the thickness data, for more information of the data format see page 76.

² To connect the TSR the Cygnus UW gauge must have an integral Impulse Connector fitted.

6. Using the Topside Repeater Display

The Cygnus Topside Repeater Display unit is a small battery powered unit with a LCD display that mimics the display of the Cygnus UNDERWATER gauge. It connects directly to the Cygnus UNDERWATER gauge via a single-pair umbilical cable.



Mk4 Cygnus Topside Repeater

Turning the Unit On

<p>1.</p>	<p>Press the red ON button</p>	
<p>2.</p>	<p>The Cygnus Logo screen appears</p>	
<p>3.</p>	<p>If not connected to a CygnusUNDERWATER Gauge the display shows "NO CONNECTION". <u>This is normal</u> – it just means no data has been received yet</p>	

Turning the Unit Off

1.	Press the red OFF button	
-----------	--------------------------	---

Changing the Displayed Units

To change the displayed measurement units between metric (mm) and imperial (inch) press the left MENU key, the UNITS setting will be highlighted, then press the middle EDIT key to change the units. Please note this does not change the units shown on the thickness gauge itself.

Display Hold Function

The middle key HOLD can be used to freeze the display and thus hold the current thickness measurement. Press the middle key again to release the HOLD function.

Automatic Display Backlight

The display backlight automatically turns off in bright light conditions, it will automatically turn on when the ambient light level drops.

Connecting to the Cygnus UNDERWATER Gauge

1.	An umbilical cable is used to connect the Cygnus UNDERWATER gauge to the Topside Repeater Display unit	
-----------	--	--

2.	The Lemo connector plugs into the top of the Topside Repeater Display unit Align the red marks on the plug and socket	
3.	Remove the Impulse blanking plug from the UNDERWATER gauge	
4.	The Impulse plug on the umbilical plugs into the Impulse socket on the UNDERWATER gauge Secure the plug with the rubber strap	

Testing the Link

Before use on a dive it is recommended to test the link between the Cygnus UNDERWATER Gauge and the Topside Repeater Display unit. To do this simply power on both the display and the gauge then measure the test block – the Topside Repeater Display should display the same result as the Cygnus UNDERWATER gauge.

Troubleshooting - Error Messages

1.	NO CONNECTION	<p>The Topside Repeater Display has not received any valid data since power-up</p> <p>Check that the Cygnus UNDERWATER Gauge is turned on and displaying either a measurement or the echo strength bar-chart</p> <p>Check all cable connections are secure</p>
-----------	------------------	--

7. CygLink Surface Display and Control Kit

CygLink is a Windows® application for PCs that allows remote viewing, control and data logging of the Cygnus UNDERWATER gauge. The software can provide the following functionality:

1. Surface display of thickness measurements
2. Data Logging of thickness measurements into a Survey report
3. Create a PDF report of a survey
4. Export data from the survey to a CSV file

Kit Contents

The CygLink kit comprises of the following items:

1. USB-RS485 Converter Cable
2. CygLink Software Installer on USB Flash Drive

You will also need an Umbilical cable and connectors to connect the Cygnus UNDERWATER gauge to the top side. Cygnus can supply the complete umbilical cable with connectors fitted, or the customer can make their own umbilical cable using connectors supplied with cable tails.

Connection Diagram

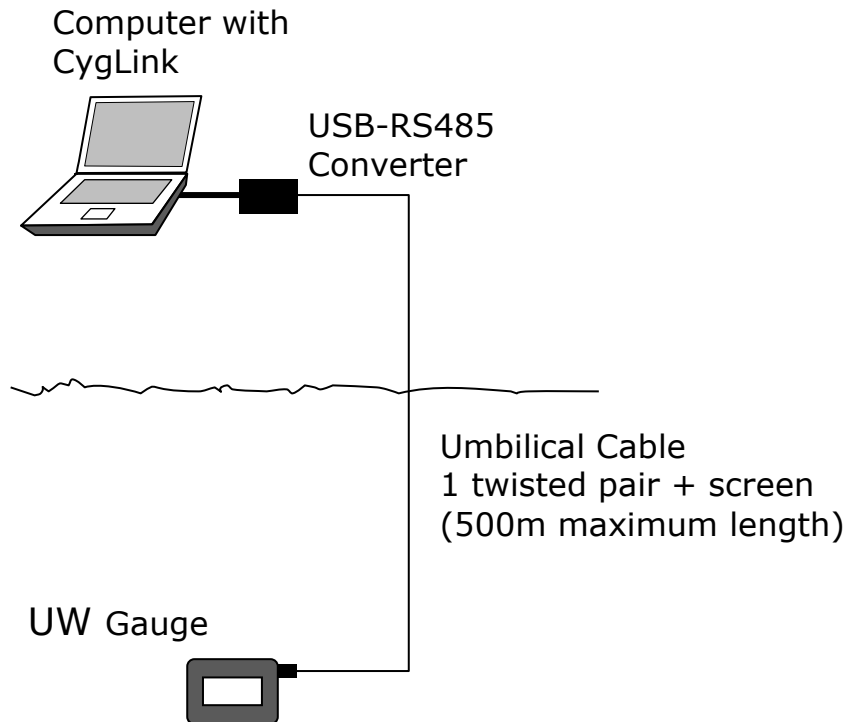

Connector Details and Signals

See Page 76 for wiring details.

Installing CygLink

CygLink is supplied with the kit on a USB Flash Drive, or it can be downloaded from the Cygnus Instruments website. If you want to make sure you are installing the latest version then downloading from the website is the best route.

Requirements

To install and run CygLink the computer must:

1. Be running Windows 7 or a newer version
2. Have sufficient resources for Microsoft .NET Framework installation
3. We recommend a screen resolution of 1280 x 720 or greater
4. We recommend at least 1GB of memory

Upgrading

You can check the Cygnum Instruments website for the latest version of CygLink.

 If you are upgrading from an older version of CygLink then you must uninstall the old version of CygLink first.

Installing

If you downloaded the CygLink installer file from the Cygnum website then this is a single self-extracting ZIP file.

Simple double click the 'setup' or 'CygLink...' exe file to start installation. You will need to agree to the license terms and conditions. There are no options to select so installation is straight forward.

Running CygLink Application

Once installed, CygLink will place shortcuts in the start menu and on the desktop. Click either shortcut to start CygLink.

Connecting to the Gauge

First time USB Connection

When you first connect the gauge to the computers USB port Windows will search for a suitable driver, you may notice this message from the taskbar;

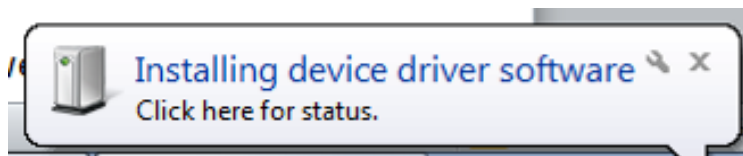

COM Port Numbers

CygLink should automatically find the COM port number assigned to the USB converter when you click "Discover.." so you don't need to search for the port number Windows has assigned.

Connecting the Gauge to CygLink for the First Time

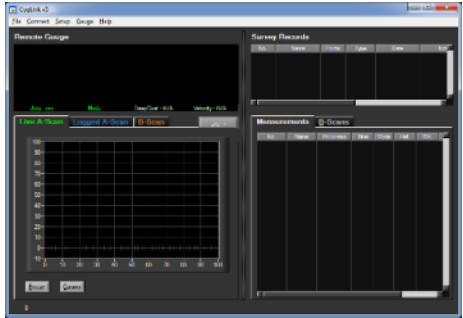
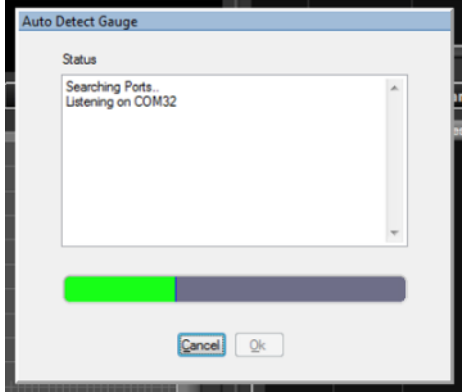
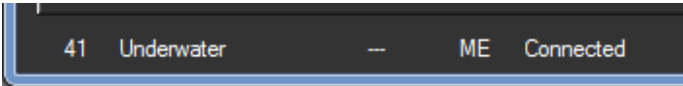
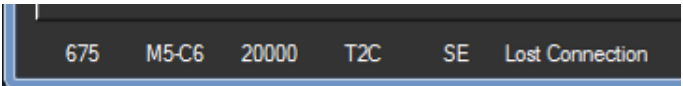
<p>1.</p>	<p>Turn on the gauge</p>	
<p>2.</p>	<p>Run CygLink V5</p>	
<p>3.</p>	<p>From the Menu click; Connect ↳ Discover new Gauge and Connect</p>	
<p>4.</p>	<p>CygLink will search all the available Com ports listening for a Cygnus gauge..</p> <p>If a gauge is detected then it will connect and save these settings for next time.</p>	
<p>5.</p>	<p>When connected you should see details of the gauge in the status bar at the bottom and 'Connected'</p>	
		
<p>6.</p>	<p>If the connection is ever lost the status bar will show 'Lost Connection'</p>	
		

Connecting to the Gauge Afterwards

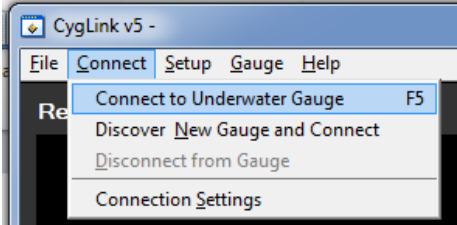
<p>1. Once you have discovered the Gauge the connection settings will be stored for next time, so to connect next time simply click from the menu;</p> <p>Connect ↳ Connect to Underwater Gauge</p>	
---	--

Disconnecting from the Gauge

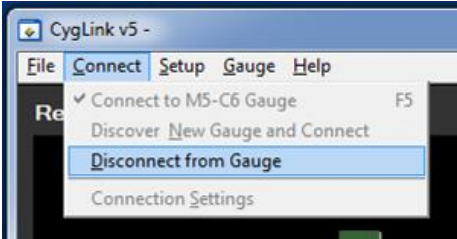
<p>1. To disconnect from the Gauge simply click from the menu;</p> <p>Connect ↳ Disconnect from Gauge</p>	
---	--

Manual Connection Settings

If you need to manually set the connection settings then select the **Connection Settings** option from the **Connect** menu, here you can specify the COM Port number, gauge type and baud rate.

Status Bar

At the bottom of the CygLink screen is the Status Bar, it shows information about the gauge and the connection.



Status Bar

From left to right;

1. Received message counter (increase as message arrive from the gauge)
2. The Gauge Model number
3. The gauge’s measurement mode

4. The connection state (Connected, Lost Connection, Disconnected)

Surveys

A Survey is a container for all your data logged measurements. A Survey can be saved to a single file which can be copied or send electronically to another CygLink user. The Survey file is binary and cannot be tampered with.

Creating a new Survey

You don't have to create a Survey but it does create the container for any measurements that you log from the gauge. If you intend to save the records logged then you will need to create a survey file anyway.

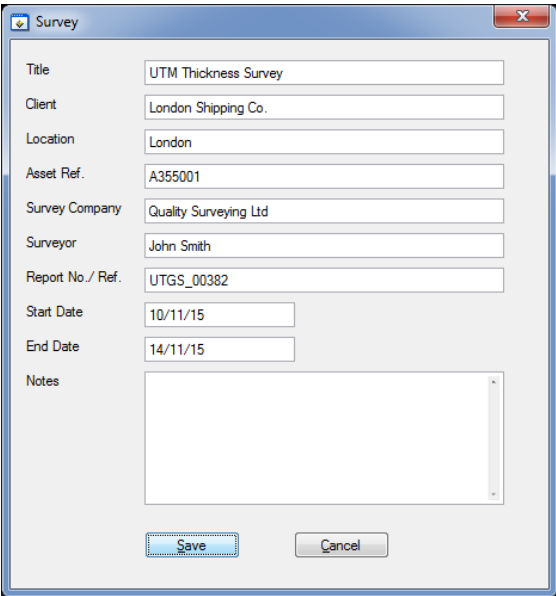
<p>1.</p>	<p>From the Menu click; File L New Survey</p>	
<p>2.</p>	<p>Complete as many fields as required, you can always go back and edit this information.</p> <p>This information will appear on the PDF report and the export to CSV file output.</p>	
<p>3.</p>	<p>You can save your new Survey to a file, from the Menu click; File L Save Survey</p> <p>Entering your filename and location.</p>	

Opening an Existing Survey

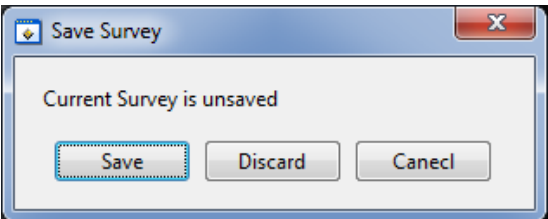
<p>1.</p>	<p>From the Menu click; File L Open Survey</p>	
<p>2.</p>	<p>You may be prompted to save any unsaved data first</p>	

Editing the Survey Info

<p>1.</p>	<p>From the Menu click; File L Edit Survey Info</p>
------------------	---

Managing the Survey

Sorting Survey Records

You can sort some of the columns in the Survey Records list by clicking on the column header. A column that has been sorted is marked with an asterisk after the column name. Clicking the column header a second time will toggle between an ascending or descending sort.

No.	Name	Points*	Type	Date	Notes	State	Gauge	S/No	Title
1	091215-110546	35	Grid 2D	09-Dec-15 11:05		Open	M5-C6	20000	
2	091215-095752	30	Linear	09-Dec-15 09:57		Open	M5-C6	20000	
3	091215-135853	30	Grid 2D	09-Dec-15 13:58		Open	M5-C6	20000	
4	091215-125403	20	Template	09-Dec-15 12:54		Open	M5-C6	20000	T20_UF
5	091215-134513	0	Linear	09-Dec-15 13:45		Open	M5-C6	20000	

Survey Records List

Survey list columns that can be sorted;

- Name (ascending or descending)
- Points (ascending or descending)
- Type
- Date (ascending or descending)

Viewing Record Information

You can view the details of a record by right-clicking on the record in the list which will display a context menu, select the Properties item.

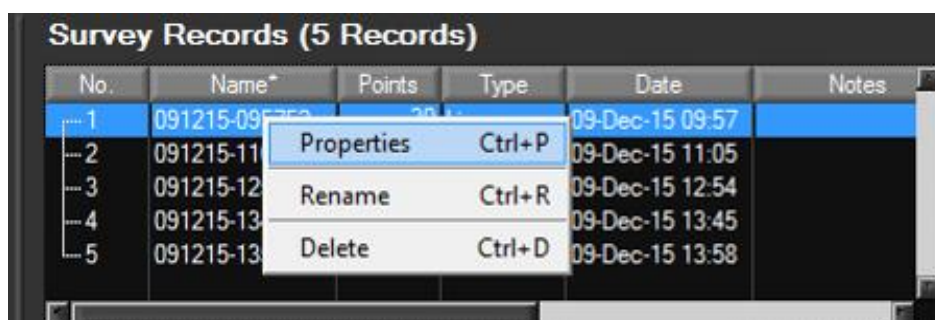

Record Properties Screen

The Record Properties will be displayed;

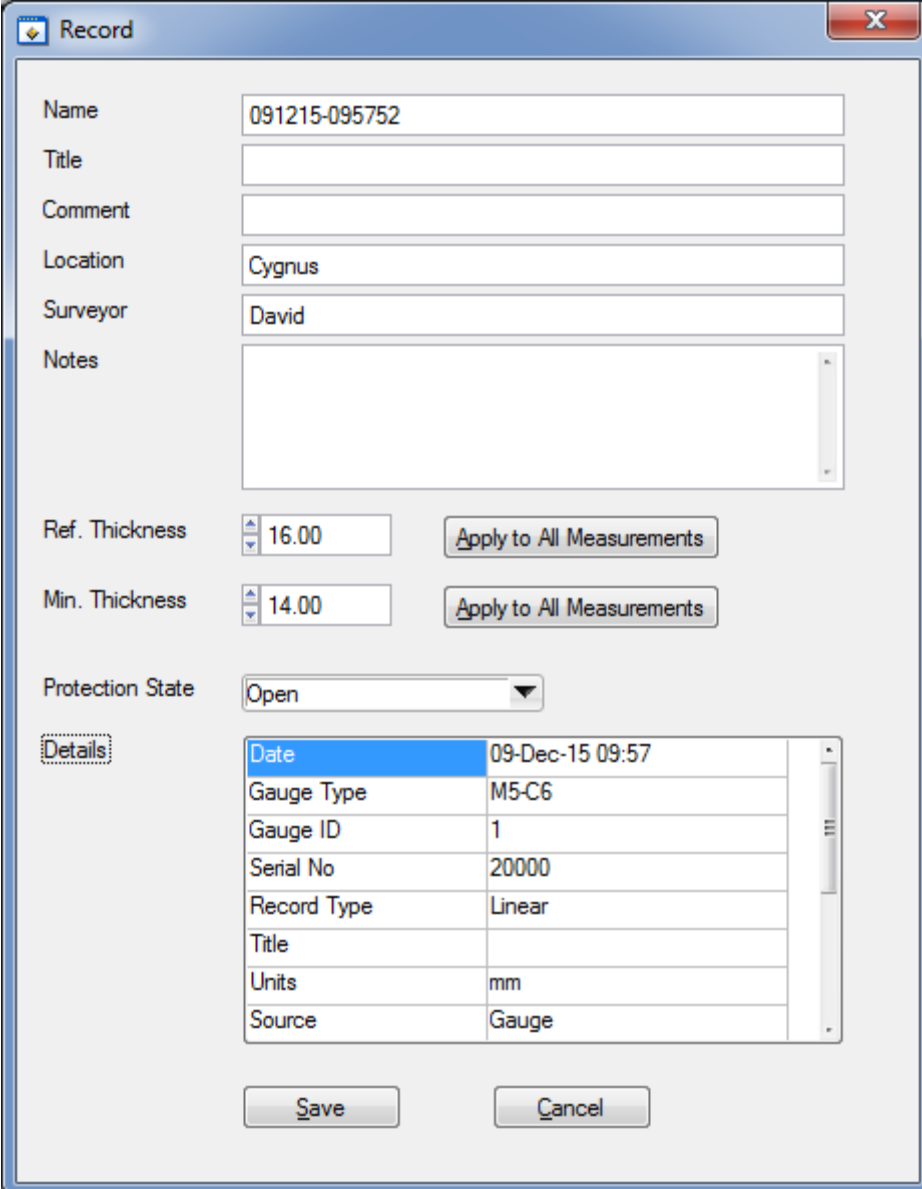

The image shows a software window titled "Record" with a close button (X) in the top right corner. The window contains several input fields and controls:

- Name:** 091215-095752
- Title:** (empty)
- Comment:** (empty)
- Location:** Cygnus
- Surveyor:** David
- Notes:** (empty text area)
- Ref. Thickness:** 16.00, with an "Apply to All Measurements" button.
- Min. Thickness:** 14.00, with an "Apply to All Measurements" button.
- Protection State:** Open (dropdown menu)
- Details:** A table with the following data:

Date	09-Dec-15 09:57
Gauge Type	M5-C6
Gauge ID	1
Serial No	20000
Record Type	Linear
Title	
Units	mm
Source	Gauge
- Buttons:** Save and Cancel.

Record Properties Screen

You can edit the fields in this screen, the **Details** table is read only and contains details about the record and summary information about its measurements.

Ref and Min Thickness

You can set and apply a Reference and Minimum thickness value for the record, click the **Apply..** button to apply this values to the measurement points in the record.

Protection State

You can set a record to be Protected or Open, when Protected it will prevent users from editing the measurement points or deleting them.

Measurement Summary Stats

If you scroll down the **Details** table you will see summary information about the measurements contained in the records;

Source	Gauge
Protection State	Uploaded
Number of Points	30 Measurements (30 in Total)
Minimum Thickness	2.69 mm
Maximum Thickness	42.92 mm
Mean Thickness	14.54 mm
Thickness Range	40.23 mm
User Fields	No

Record Properties Screen - Stats

2. This information will appear on the PDF report and the export to CSV file output.

Survey

Title: UTM Thickness Survey

Client: London Shipping Co.

Location: London

Asset Ref.: A355001

Survey Company: Quality Surveying Ltd

Surveyor: John Smith

Report No./ Ref.: UTGS_00382

Start Date: 10/11/15

End Date: 14/11/15

Notes:

Save Cancel

Logging Measurements in CygLink

You can use CygLink to log the top-side thickness measurements into the Survey so they can be presented in the Survey report.

Logging Measurements

Clicking the **Log** button next to the thickness measurement will first ask you to create a new Group. Further clicks of the **Log** button will then add each thickness measurement to this Group. There is no limit to the amount of measurements that can be added to each Group.



Topside Thickness Measurement and Log Button.

Grouping Measurements in Survey Records

If you need to organise your measurements into separate groups then you can create separate Survey Records for each group of measurements. From the menu click **File -> New Survey Record** you can then select this new Record and begin logging into it.

Viewing Thickness Measurements in a Record

To display the list of thickness measurements in a record click on the record in the **Survey Records** list, the **Measurements** tab below will display the measurements belonging to the record;

Survey Records (5 Records)

No.	Name*	Points	Type	Date	Notes
1	091215-095752	30	Linear	09-Dec-15 09:57	
2	091215-110546	35	Grid 2D	09-Dec-15 11:05	
3	091215-125403	20	Template	09-Dec-15 12:54	
4	091215-134513	0	Linear	09-Dec-15 13:45	
5	091215-135853	30	Grid 2D	09-Dec-15 13:58	

Measurements (30) B-Scans (0)

No.	Name	Thickness	Time	Mode	Ref.	Min.	C
1	P1	14.00	09:58	SE	16.00	14.00	
2	P2	15.09	09:58	SE	16.00	14.00	
3	P3	14.54	09:58	SE	16.00	14.00	
4	P4	13.81	09:58	SE	16.00	14.00	
5	P5	13.63	09:58	SE	16.00	14.00	
6	P6	13.36	09:58	SE	16.00	14.00	
7	P7	13.17	09:58	SE	16.00	14.00	
8	P8	12.90	09:58	SE	16.00	14.00	
9	P9	14.16	09:58	SE	16.00	14.00	
10	P10	14.15	09:58	SE	16.00	14.00	
11	P11	13.21	09:58	SE	16.00	14.00	
12	P12	13.21	09:58	SE	16.00	14.00	
13	P13	14.25	09:58	SE	16.00	14.00	
14	P14	14.22	09:58	SE	16.00	14.00	
15	P15	14.02	09:58	SE	16.00	14.00	
16	P16	42.92	09:58	SE	16.00	14.00	
17	P17	13.60	09:58	SE	16.00	14.00	
18	P18	11.80	09:58	SE	16.00	14.00	
19	P19	12.16	09:58	SE	16.00	14.00	

Record and Measurements Tab

Managing Measurements

You can right-click a selected measurement to display the context-menu;

Measurements (30) B-Scans (0)

No.	Name	Thickness	Time	Mode	Ref.	Min.	C
1	P1	14.00	09:58	SE	16.00	14.00	
2	P2	15.09	09:58	SE	16.00	14.00	
3	P3	14.54	09:58	SE	16.00	14.00	
4	P4	13.81	09:58	SE	16.00	14.00	
5	P5	13.63	09:58	SE	16.00	14.00	
6	P6	13.36	09:58	SE	16.00	14.00	
7	P7	13.17	09:58	SE	16.00	14.00	
8	P8	12.90	09:58	SE	16.00	14.00	

Context Menu:

- Find... Ctrl+F
- View A-Scan
- Properties Ctrl+E
- Rename Ctrl+R
- Delete Point Ctrl+D

Measurements Context Menu

This menu allows you to **Find**, **Rename** and **Delete** a measurement point, you can also view information about the measurement or display it's **A-Scan** graph if it has one.



Note there is no undo function - once deleted the measurement point is lost, unless you have saved a copy of the survey or the record is still saved on the gauge.

Viewing Measurement Information

Clicking Properties from the context menu will display the measurement properties screen;

Details	
Point Type	Normal
Source	Gauge
Date	09-Dec-15 09:58
Thickness	14.00 mm
Units	mm
Measurement Mode	Single Echo
Resolution	High
Velocity	5920
Deep Coat	Off
Temp. Comp.	Non
Probe Type	T5B
Has A-Scan	Yes
Gain	35 dB

Measurements Properties Screen

Adding Comments to Measurements

You can add comments to a measurement point using the measurement properties screen. The **Notes** field can be directly typed into or you can click the **Add From Comments** button to select a comment from the pre-defined list.

Comments will appear next to the measurement in the PDF report.

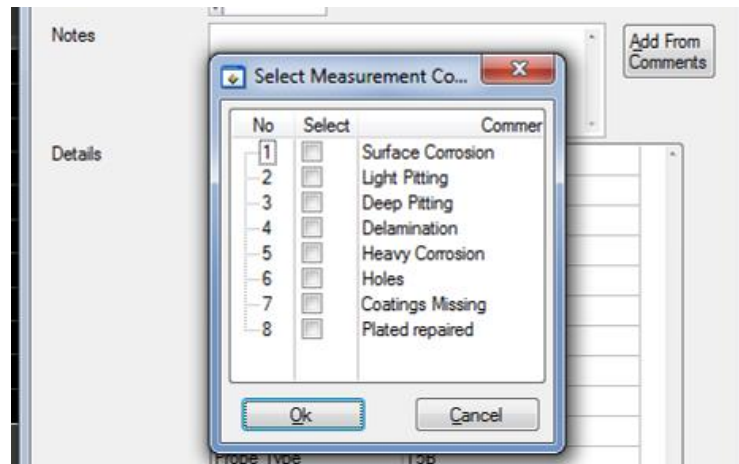

Selecting Measurements Comments from the List

Just select the required comments in the list and click **Ok**.

Measurement Comment List

The Measurement Comment List is a list of 8 pre-set text comments that can be added to data logged measurement points.

- | | |
|-----------|--|
| 1. | From the Menu click;
File
↳ Measurement Comments |
| 2. | You can then Add, Edit, or Remove the entries in the comment list |

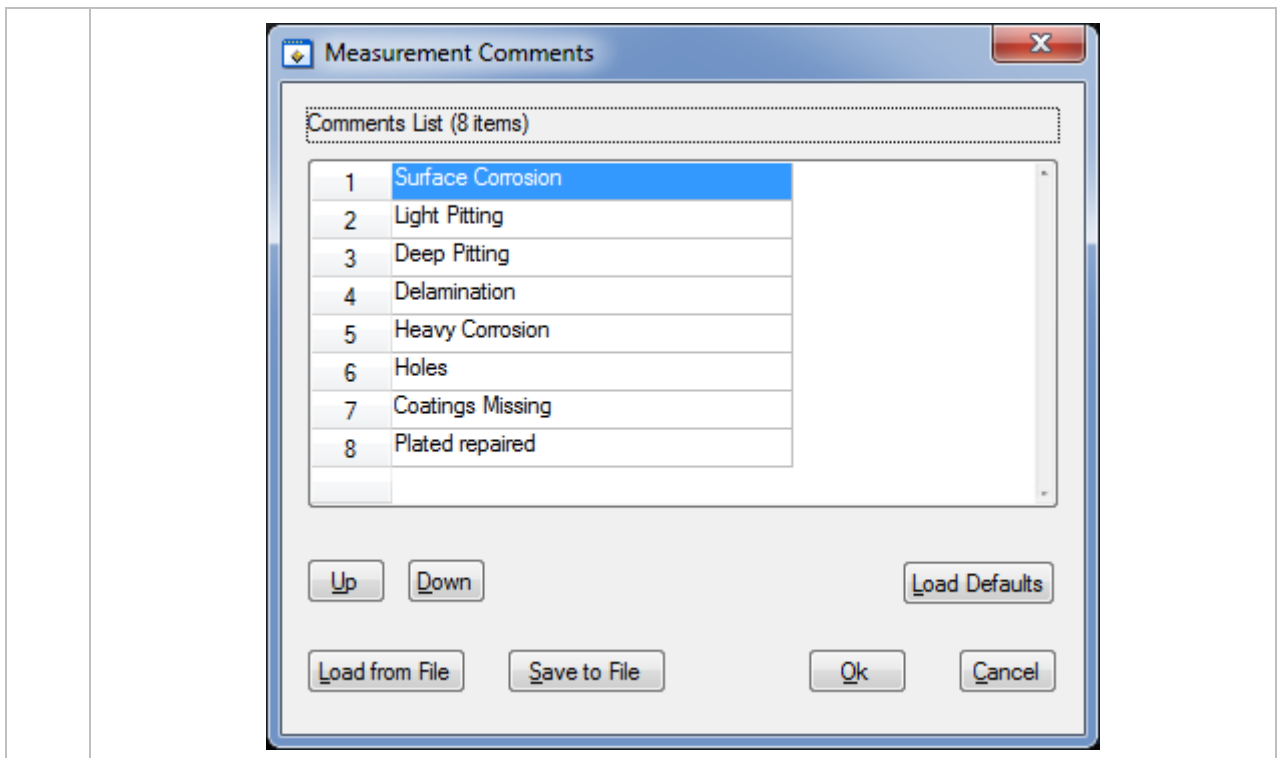

Creating a PDF Survey Report

A PDF report can be produced containing all the Survey Records and thickness measurements in the Survey, grouped by each Survey Records. Once the export process is complete, your report will automatically be displayed in your installed PDF viewer. The export may take a few seconds, depending on the number of measurements contained in the survey.

1. From the Menu click;
File
 ↳ **Create Survey Report PDF**

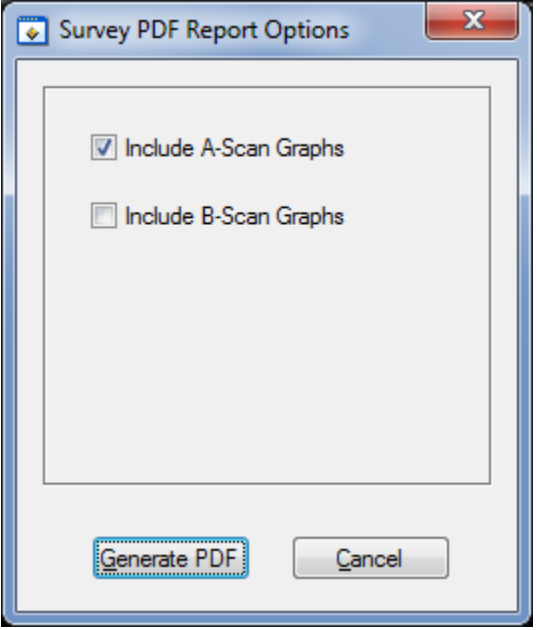
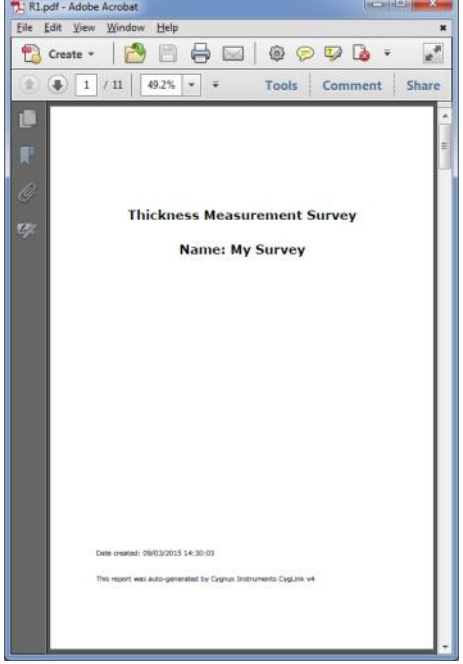
2.	You can choose to include A-Scan and/or B-Scan graphs in the report.	
3.	A report filename may be suggested, you can continue with the filename or type your own as required.	
4.	The report is then created and will open in your PDF viewer.	
5.	The PDF report is arranged into the following sections; <ul style="list-style-type: none">• Title Page• Survey Details Page• Survey Record details and measurements for each survey• Appendix of all the A-Scan Graphs• Appendix of all the B-Scan Graphs	

Exporting a Survey to a CSV File

You can export the textual and numeric data from the whole survey to a CSV³ file that can be opened with a spreadsheet such as Microsoft Excel. An example of a CSV export opened in Excel is shown below;

1.	From the Menu click; File └ Export Survey to CSV File
2.	A filename may be suggested, you can continue with the filename or type your own as required.

³ CSV - Comma Spaced Variable

Survey Details											
Client Company	ACME Shipping										
Inspection Site	South Port										
Survey Company	Right Survey Ltd										
Start Date	09/03/2015										
Type of Inspection	Corrosion Survey										
Asset Reference	AF350-01										
Notes	GL Classified, 15 years old.										
Survey Groups											
020315-101523											
Surveyor	John Smith										
Start Date	09/03/2015										
Completed	No										
Record Type	Blank										
Gauge Type	M5-C6										
Gauge Serial Number	11002										
Reference Thickness	12										
Minimum Thickness	6										
Min	13.9										
Max	14										
Notes	Location A35. Deck Plate.										
Measurements											
Name	Thickness	Units	Time	Mode	Velocity	Ref	Min	Probe	Source	Notes	
MP1	13.9	mm	10:16:47	Multiple Echo	5920	12	6	S3C	Upload		
MP2	14	mm	10:16:50	Multiple Echo	5920	12	6	S3C	Upload		
MP3	14	mm	10:16:51	Multiple Echo	5920	12	6	S3C	Upload		
MP4	13.9	mm	10:16:51	Multiple Echo	5920	12	6	S3C	Upload		
MP5	13.9	mm	10:16:52	Multiple Echo	5920	12	6	S3C	Upload		
MP6	13.9	mm	10:16:52	Multiple Echo	5920	12	6	S3C	Upload		
MP7	13.9	mm	10:16:52	Multiple Echo	5920	12	6	S3C	Upload		
MP8	13.9	mm	10:16:52	Multiple Echo	5920	12	6	S3C	Upload		
MP9	14	mm	10:16:53	Multiple Echo	5920	12	6	S3C	Upload		
MP10	14	mm	10:16:53	Multiple Echo	5920	12	6	S3C	Upload		
MP11	13.9	mm	10:16:53	Multiple Echo	5920	12	6	S3C	Upload		
MP12	13.9	mm	10:16:53	Multiple Echo	5920	12	6	S3C	Upload		
MP13	13.9	mm	10:16:54	Multiple Echo	5920	12	6	S3C	Upload		
MP14	13.9	mm	10:16:54	Multiple Echo	5920	12	6	S3C	Upload		

Survey CSV Export opened in Excel.

CygLink Trouble Shooting

Setting the COM Port Manually

If CygLink fails to locate the correct COM port number you can set in manually from the **File -> Communications Options** menu item. Just tick the **Manual Setup** box and select the correct COM port number.

Finding your COM Port Number

With the USB-RS485 Converter plugged into your computer, open Windows Device Manager – to do this press the Windows® key and the 'R' key together, then type "**devmgmt.msc**" into the prompt followed by enter key. In the **Ports** section, look for the

USB Serial Port entry. Remember the COM number listed, as this will need to be selected within CygLink's settings menu.

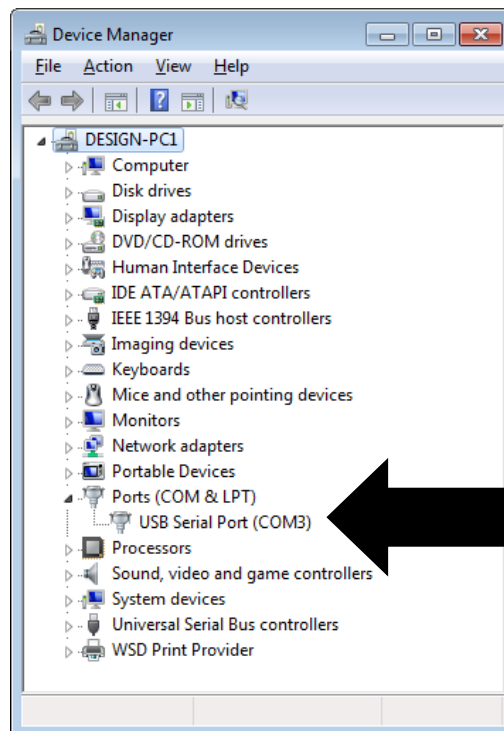

Windows® Device Manager

To Change the COM Port number assigned by Windows®

Depending on a variety of factors, Windows® may sometimes assign a COM Port number that is too high or unusual to be easily remembered. You may change the number assigned to the port by following these steps:

Opening Device Manager

Each version of Windows has a slightly different procedure for opening Device Manager. The most direct route is to press **Windows + R**, type "devmgmt.msc" and press Enter.

1. Select the "**USB Serial Port**" device and right click to display its context menu, Click "**Properties**".

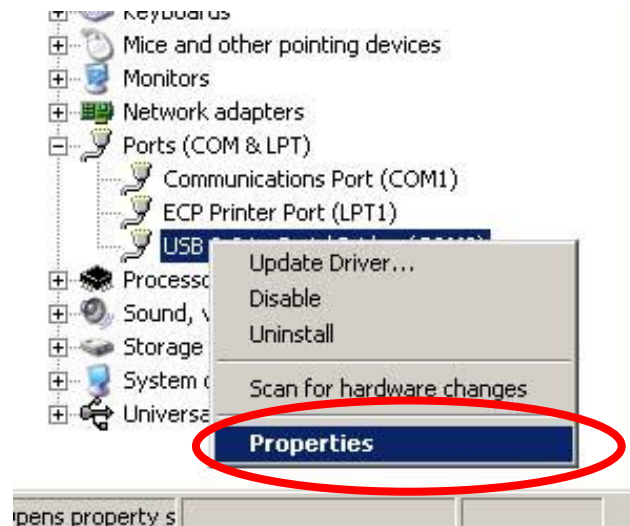

2. On the Properties form select the **"Port Settings"** tab, then click the **"Advanced"** button.

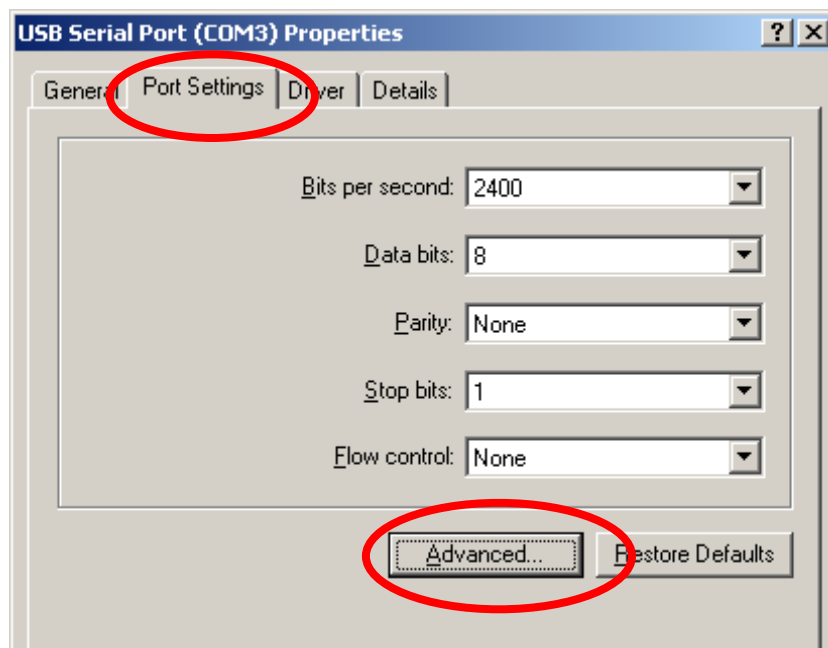

3. On the **"Advanced Settings"** form you can change the COM Port number. Finish by clicking the **"OK"** button.

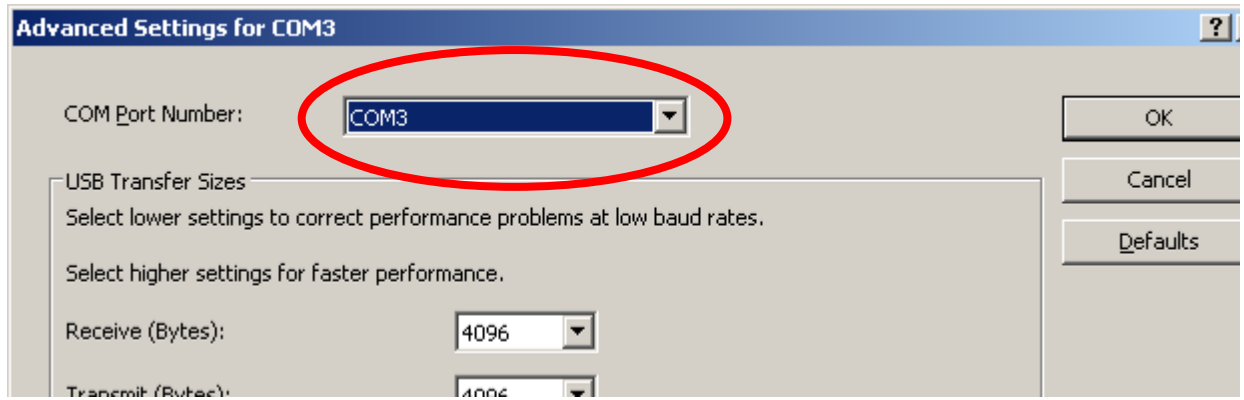

Connection Problems – USB Drivers

If you are unable to get a connection the first thing to try is updating the USB drivers for the Serial to USB converter. Windows is constantly being updated and as a result drivers also need to be updated to keep track of changes.

The Serial to USB converter used for the Cygnus UNDERWATER gauge is manufactured by KK Systems and uses Prolific drivers. You can search the web for the latest drivers from Prolific;

Type this into Google search "**KK SYSTEMS USB232**"

Or follow this link directly to the KK Systems website;

http://www.kksystems.com/english/html_files/software.htm
Follow the instructions for USB232 Windows Drivers.

Wiring Problems

Sometimes the cable between the Cygnus UNDERWATER gauge and the USB converter is damaged, or has been repaired incorrectly. Although there are only 2 data wires they must be connected the correct way around. Double check the connections from the gauge's connector to the serial converter connection.

If you have the short serial to USB interface cable – check the gauge can connect to CygLink using this cable – if it works then the USB driver must be ok, the problem may lie in the long umbilical cable.

8. Connecting the UNDERWATER Gauge to the Computer

<p>1.</p>	<p>An umbilical cable is used to connect the Cygnus UNDERWATER gauge to the USB-485 converter module</p>	
<p>2.</p>	<p>Remove the Impulse blanking plug from the Cygnus UNDERWATER gauge</p>	
<p>3.</p>	<p>The Impulse plug on the umbilical plugs into the Impulse socket on the Cygnus UNDERWATER gauge</p> <p>Secure the plug with the rubber strap</p>	

For details of the **Electrical Connections** see page 76 Topside Repeater Electrical Connections.

9. Probes & Membranes

-  The Gauge should only be used with Soft-Faced probes supplied by Cygnus Instruments.

Cygnus Soft-Faced probes are fitted with a Polyurethane Membrane which provides better contact on rough surfaces and protects the probe face from wear, prolonging the life of the probe.

Check the membrane regularly as it is important the membrane is changed as soon as it shows any signs of wear.

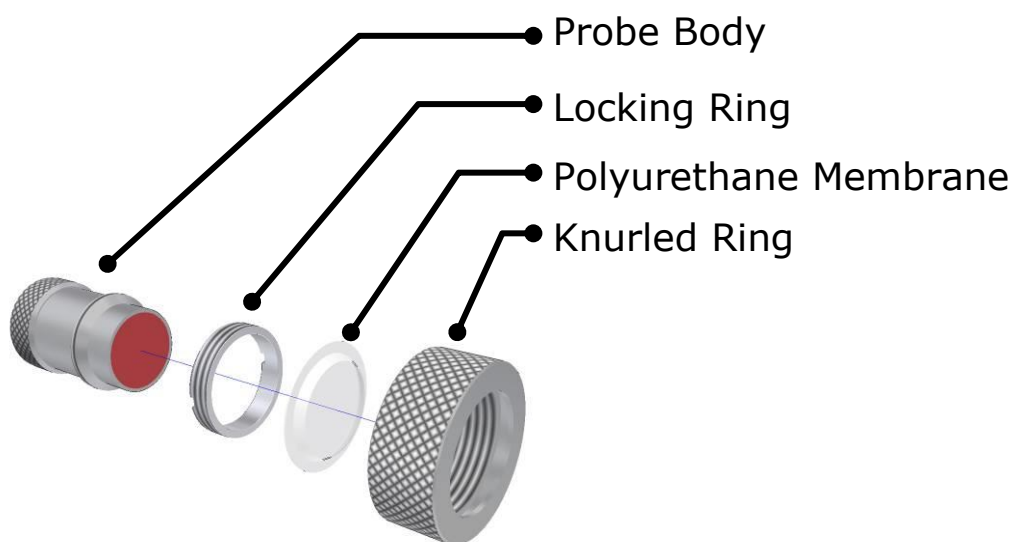





Probe Selection

Apart from the physical limitation of the probe size, the diameter of the probe face (crystal) and the frequency affects the probe performance, generally:

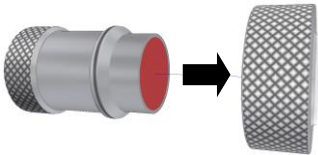
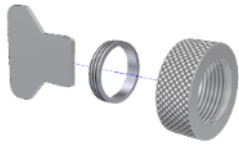
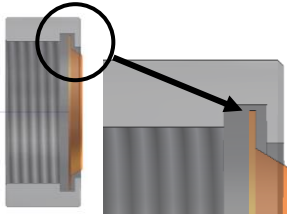
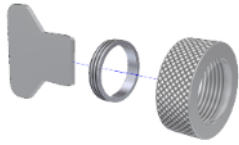
- Large diameter probes produce more energy which gives better performance on heavily corroded or coated materials.
- Higher Frequency probes produce a narrower focused beam which is better when looking for small features or on thin materials.

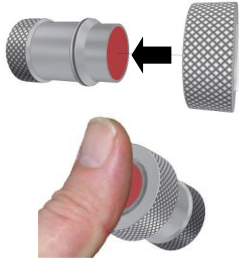
Changing the Membrane

<p>1.</p>	<p>Unscrew the Knurled Ring from the end of the Probe</p>	
<p>2.</p>	<p>Use the Locking Ring Key to unscrew the Locking Ring from inside the Knurled Ring. The old membrane can then be removed and discarded</p>	
<p>3.</p>	<p>Place a new membrane into the end of the Knurled Ring ensuring it locates in the groove</p>	
<p>4.</p>	<p>Screw the Locking Ring back inside the Knurled Ring and tighten with the Locking Ring Key</p>	
<p>5.</p>	<p>Place a few drops of Membrane Couplant on to the probe face</p>	
<p>6.</p>	<p>Screw the Knurled Ring back onto the probe. Use your thumb to squeeze the couplant from under the membrane as you tighten the Knurled Ring down</p>	
<p>7.</p>	<p>You should see the membrane has a very thin film of couplant between itself and the probe face with <u>no air bubbles</u></p>	

Probe Selection & Specifications

Crystal Diameter	Frequency	Measurement Range	Application
13 mm ½ inch	2¼ MHz	3.0 – 250 mm ⁴ 0.12 – 10 inch	This is the standard probe – suitable for most applications.
13 mm ½ inch	3½ MHz	2.0 – 150 mm 0.08 – 6 inch	Suitable for measurement on thinner sections where surfaces are relatively rough
6 mm ¼ inch	5 MHz	1.0 – 50 mm 0.04 – 2 inch	The higher frequency and narrower beam makes this Probe ideal for measuring small-bore tubing, thin section plate and other areas where access is limited.
13 mm ½ inch	5 MHz	1.0 – 50 mm 0.04 – 2 inch	Ideal for thin sections without heavy corrosion.

Lower frequency probes offer better penetration on heavy corrosion/coatings.

Probe Frequency Identification

The frequency of Cygnus probes is indicated by colour:

Old Style Probes	Inox Remote Probes
Coloured Probe Face 	Coloured Band on Probe Cap 

Red = 2.25 MHz

Orange = 3.5 MHz

Black = 5.0 MHz

⁴ To measure thicknesses on tall thin cylinders or columns the height-width ratio should be no less than 1.0:0.6 (Height:Width) otherwise side reflections prevent measurement.

10. Gauge Setup

Gauge Menu Diagram

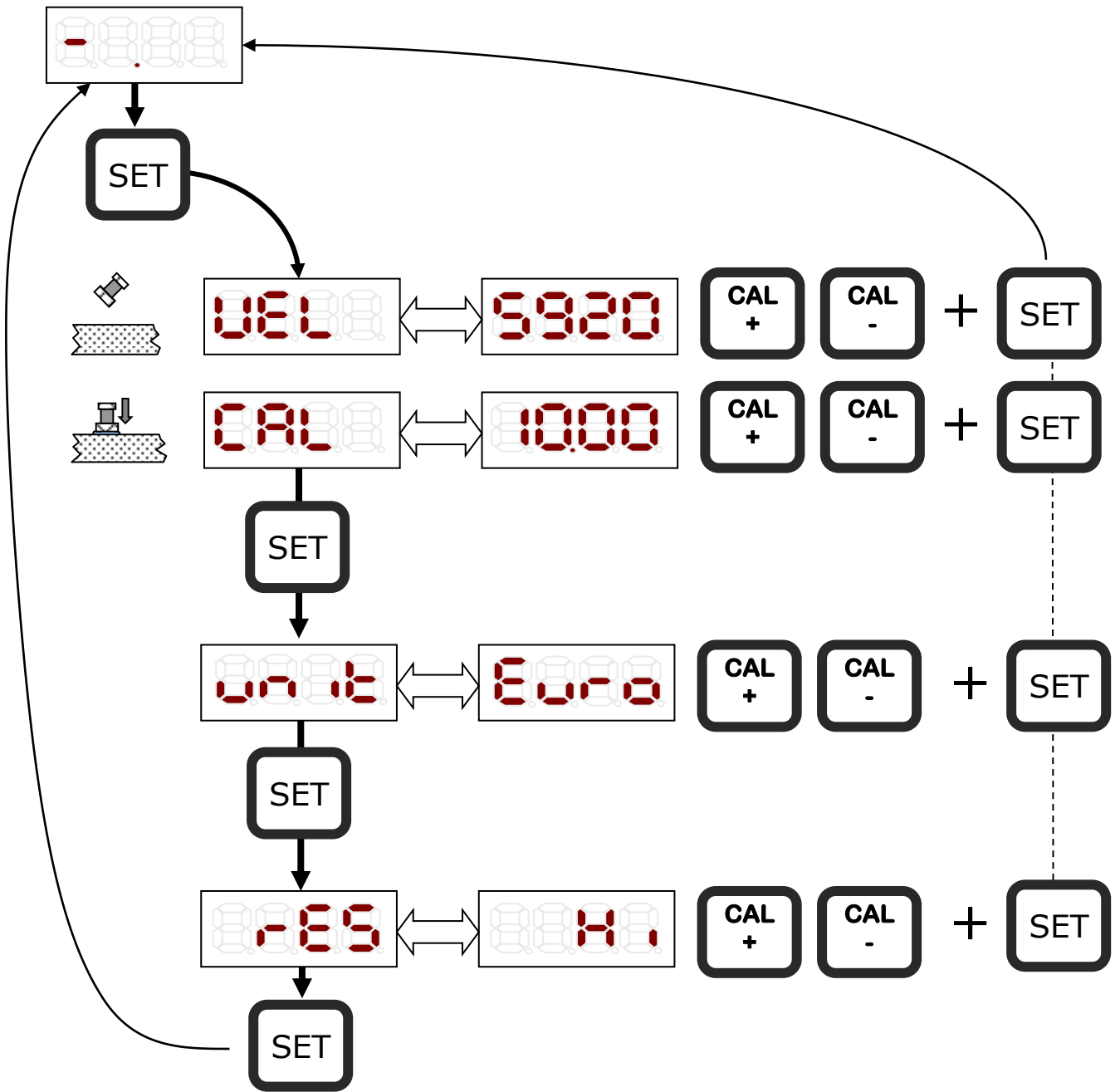

Connecting the Battery during Setup

To provide access to the setup buttons connect the battery pack to the gauge body using the calibration jumper lead supplied with the kit. Connect this lead from the battery to the connection at the battery end of the gauge as shown below.



Calibration Jumper Lead

11. Calibrating the Gauge

The Gauge is supplied tested and calibrated. The Gauge will have been calibrated to measure thickness through steel (grade S355JO).

Either a 15mm or ½" test block is supplied with the kit so the Gauge can be quickly checked for correct operation. Note, this test block is not intended to be used for calibration of the Gauge and may not indicate an exact 15.00 mm.





The best way to calibrate the Gauge is to calibrate using a Known Thickness sample of the material you intend to measure. This method determines the velocity of sound for the material sample, which will always be more accurate than using a 'general' velocity value. For calibration instructions see page 63.

If there is no test sample available the Gauge can be calibrated by setting the Velocity of Sound directly. A table on page 80 at the back of this manual lists common materials and their velocity of sound value. For calibration instructions see page 64.

A third method is to leave the Gauge set to its factory-preset value for Steel [5920 m/s or 0.2332 in/us], and then use a Conversion Factor from the table of velocities on page 80.

Calibrating to a known thickness (Single Point)

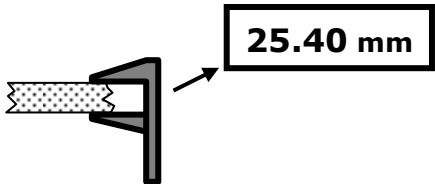
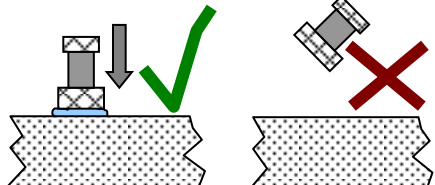
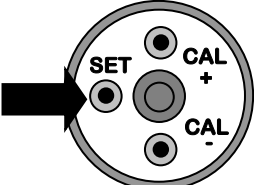

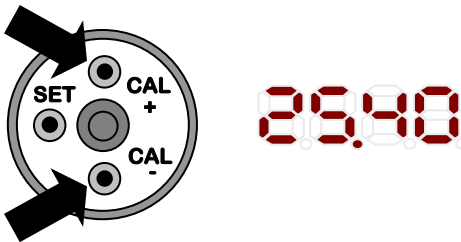
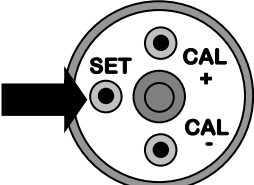
This method of calibrating the Gauge is the most accurate as the Gauge calculates the velocity of sound for the sample material.

<p>1.</p>	<p>Accurately measure the thickness of your sample material</p>	
<p>2.</p>	<p>Place the Probe on the sample so the Gauge is displaying a thickness value</p>	
<p>3.</p>	<p>Press the SET button once to display the Gauge setup menu</p>	
<p>4.</p>	<p>The display flashes the current thickness value</p>	
<p>5.</p>	<p>Use the CAL+ and CAL- buttons to change the thickness value until it reads the correct value as measured in '1'</p>	
<p>6.</p>	<p>Press the SET button to save the new calibration</p>	
<p>7.</p>	<p>Repeat from Step 2 until the calibration is accurate and consistent.</p>	

Setting the Velocity of Sound

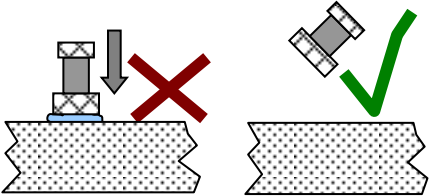
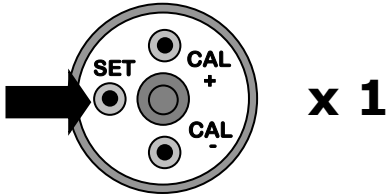

The Gauge uses the Velocity of Sound value to calculate the material thickness value from the matched triple-echo time.

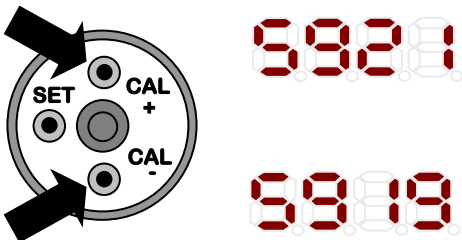
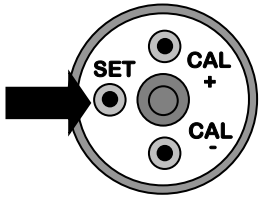
A table at the back of this manual lists velocity of sound values (on page 80) for common materials.

<p>1.</p>	<p>Ensure the probe is not touching anything so the Gauge is not displaying a thickness value</p>	
<p>2.</p>	<p>Press the SET button once to display the Gauge setup menu</p>	
<p>3.</p>	<p>The display flashes the current Velocity of Sound value</p>	
<p>4.</p>	<p>Use the CAL+ and CAL- buttons to change the value</p>	
<p>5.</p>	<p>Press the SET button to save the new velocity value</p>	

Measurement Units

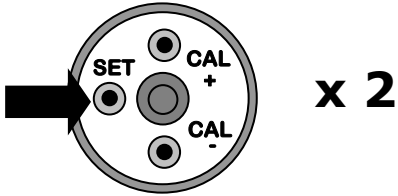
The Gauge can display thickness measurements in either Metric (mm) or Imperial (inch). Changing the measurement units will not affect the calibration.

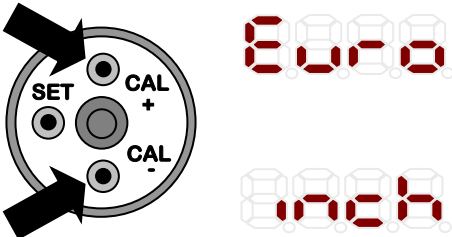
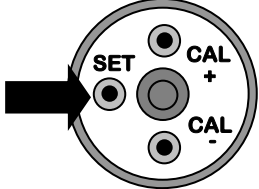

<p>1.</p>	<p>Press the SET button 2 times to enter the Gauge setup menu and display the Measurement Units</p>	
<p>2.</p>	<p>The display flashes the current Measurement Unit value</p>	
<p>3.</p>	<p>Use the CAL+ and CAL- buttons to change between the two unit settings</p> <p>Note. Euro = mm</p>	
<p>4.</p>	<p>Press the SET button to save the new Measurement Units</p>	

Resolution Setting

The Gauge can display the thickness measurements in two resolutions:

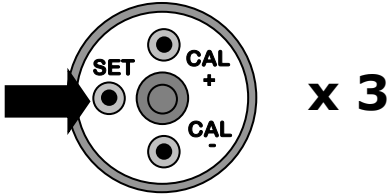

- High Resolution : 0.05 mm / 0.002 inch
- Low Resolution : 0.1 mm / 0.005 inch

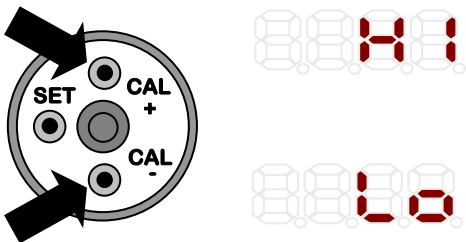
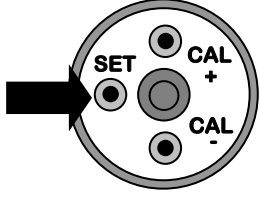
To change the Resolution setting:

<p>1.</p>	<p>Press the SET button 3 times to enter the Gauge setup menu and display the Resolution setting</p>	
<p>2.</p>	<p>The display flashes the current Resolution setting</p>	
<p>3.</p>	<p>Use the CAL+ and CAL- buttons to change between the two resolution settings</p>	
<p>4.</p>	<p>Press the SET button to save the new Resolution setting</p>	

Automatic Probe Frequency Setting

The Gauge will automatically detect the frequency of the probe connected and set the Gauge accordingly. When a probe of a different frequency is connected the display will briefly show the new probe frequency detected.

	Probe Connected	Display
	2.25 MHz Probe	
	3.5 MHz Probe	
	5.0 MHz Probe	

12. General Points on Thickness Gauging

On very rough surfaces and especially if both sides are badly corroded, it is often necessary to move the Probe around to locate a back wall reflector. Sometimes a slight rocking movement can help find reflectors which are otherwise impossible.

Badly corroded sections can also be soaked with a light lubricating oil to improve ultrasound coupling through to the good material.

Always ensure that there is plenty of couplant present for good contact, but beware that on a pitted surface the Gauge may just measure the couplant-filled pit itself, always avoid measuring directly over external pits.

Beware that in extreme conditions or if the plate is of poor quality and contains many inclusions the ultrasound will be scattered to such an extent that measurement may not be possible.

Beware that the multiple-echo technique will not work if the front and back surfaces of the material being measured are not close to parallel. Also note that long narrow bars cannot be gauged along their length with the multiple-echo method.

The Gauge should not be used near arc-welding equipment, as this affects its performance.

13. Troubleshooting

The Gauge will not Switch On

- Are the batteries discharged?
- Check the battery pack is fitted correctly.

Difficulty obtaining a Reading

If there is 1 single flashing bar on the display – this means the Gauge is not receiving any echoes:

- Check that the Probe-lead is properly connected to both Probe and Gauge.
- Check the condition of the lead, replace if necessary.

If there is mostly 1 fixed bar plus 1 flashing bar this means that the Gauge is having difficulty obtaining more than one echo:

- Check the Probe and its membrane are properly assembled.

If there are up to 3 fixed bars plus 1 flashing bar, but never any reading – this means the Gauge is receiving unrelated echoes from more than one reflector:

- On heavily corroded areas this is often a problem, try and take measurements in adjacent areas of the same material.
- Check the Gauge and Probe together on a test block, if there is still no reading the Gauge may require servicing.

If Readings are Erratic or Unstable

- Check that the Probe-lead is properly connected to both Probe and Gauge.
- Check that the Probe and its membrane are correctly assembled with sufficient couplant between the probe face and membrane.
- Check the Probe-frequency is suitable for the probable minimum thickness of the material being measured. Probe

frequencies which are too low cause doubling and tripling of the actual thickness.

14. The 4 Point Check

The most frequent reasons found to cause difficulty getting readings are:

1. Is the Probe-membrane fitted correctly?

- Check that there is a thin layer of oil between the membrane and Probe-face, and with no air-bubbles trapped. See Changing the Membrane on Page 58.

2. Is the Probe-lead OK?

- Check the probe lead is in good condition and is correctly inserted into the Probe and the Gauge. See Connecting the Probe on Page 16

3. Is there adequate couplant applied to the material being measured, and is the surface properly prepared?

- Check there is plenty of couplant gel applied and there are no air-gaps between the Probe and the material when measuring in air. See Taking a Thickness Measurement on Page 23.

4. Is the material measurable at all?

- Are the front and back faces of the material parallel?
- Is the material too heavily corroded?
- Is the material too thin for the Probe being used? (See page 59)

It is often worth confirming that the Gauge is operating OK using a test sample, and also to confirm that the material can actually be measured by ultrasonic multiple-echo thickness measurement.

15. Care and Servicing

Cleaning the Gauge

- ✓ After each dive while the Gauge is still assembled, wash the unit in fresh water and allow to dry
- ✓ A mild detergent may be necessary to remove grease from the O-ring grooves
- ✗ Do not use solvents to clean the Gauge
- ✗ Do not use any abrasive cleaner, especially on the display window

O-Ring Seals

- ✓ When assembling the gauge before a dive fit a new set of O-rings (see page 19) and ensure they are lubricated with silicone grease.
- ✓ To avoid the risk of a leak: prevent accidental re-use of old O-rings by destroying them after removal

Batteries

- ✓ Always remove the battery pack if the Gauge will not be used for more than a few days
- ✓ Recharge the batteries periodically even if the Gauge will be left unused for more than a few days
- ✓ Only recharge the battery packs with the supplied charger
- ✓ Occasionally give the batteries a recharge cycle of 14-16 hours to recondition the batteries and extend their life

Environmental

- ✗ Do not subject the Gauge to temperatures greater than 60°C (140°F)
- ✗ Do not store the Gauge and its kit for long periods in conditions of high humidity

Repairs

- ✘ There are no user serviceable parts inside the Gauge. Therefore all repair work should be carried out by Cygnus Instruments or by an Authorised Cygnus Service dealer

Returning the Gauge for Servicing

A full Manufacturer's Factory Service is available from Cygnus Instruments.

-  The Complete Kit should always be returned for Service or Repair, including all Probes and Leads.

Cygnus Gauges are renowned for their reliability, very often problems with getting measurements are simply due to the way the Gauge is being used. See Troubleshooting on Page 69.

However, if you do need to return your Gauge for Repair please let us know the details of the problem, to help us guarantee the best possible service:

- Is the problem of an Intermittent Nature?
- Is there a problem turning the Gauge On?
Or a problem with the Gauge turning itself off?
- Does the Gauge consistently give Incorrect or Unsteady Readings?
- Is it not possible to calibrate the Gauge?

16. Information

Technical Specifications

General Attributes		
Size	238 mm long x 85 mm diameter (9.4 in x 3.4 in) <i>Including battery pack and probe head.</i>	
Weight	977 g (35 oz) Including Batteries	
Power Supply	Sealed Rechargeable Battery Pack. (3 x AA NiMH Cells, 4.5 v DC)	
Probe Sockets	Direct cable connection from probe-head to probe-element.	
Battery Operation Time	Approximately 20 hrs with fully charged battery pack.	
Battery Voltage Range	Min 3.0 V dc, Max 4.5 V dc	
Operating Temperature Range	-10°C to +50°C (14°F to 122°F)	
Storage Temperature Range	-10°C to +60°C (14°F to 140°F)	
Low Battery Indication	"Batt" flashed on Display.	
PRF	602 Hz	
Monitor Outputs	N/A	
Through Coating Measurements	Coatings up to 6 mm thick as standard. Coatings up to 20 mm thick in Deep Coat ⁵ mode.	
Materials	Sound Velocity from 2000 m/s to 7000 m/s [0.0800 in/uS to 0.2780 in/uS]	
Measurement Range	Measurement Ranges in Steel: 2¼ MHz probe 3 mm to 250 mm [0.120 in. to 10.00 in.] 3½ MHz probe 2 mm to 150 mm [0.080 in. to 6.000 in.] 5 MHz probe 1 mm to 50 mm [0.040 in. to 2.000 in.]	
Accuracy	±0.05 mm (±0.002")	High Resolution Mode and measurement <100.0 mm
	±0.1 mm (±0.005")	Low Resolution Mode or measurement >99.95 mm
Resolution	0.05 mm (0.002")	High Resolution Mode and measurement <100.0 mm
	0.1 mm (0.005") Selectable.	Low Resolution Mode or measurement >99.95 mm
Display		
Type of Display	4 x 7 Segment LED, Red.	
Display Size	8 mm High.	
Transmitter		

⁵ To use **Deep Coat** mode consult Cygnus Instruments Ltd.

Shape of Pulse	Square
Pulse Energy : Voltage (peak-to-peak)	30 V p-p
Pulse Energy : Rise Time	25 ns (max)
Pulse Energy : Pulse Duration	110 ns / 135 ns / 230 ns (5 MHz, 3.5 MHz, 2.25 MHz)
Receiver	
Gain Control	Automatic Gain Control up to pre-set Maximum Gain value.
Frequency Range	1.5 MHz to 5.0 MHz (-6dB)
Other Information	
Data Output and Storage	Optional RS422 serial data output to top-side repeater unit or computer (can only be factory fitted from new).
Calibration setting storage	Calibration data stored in non-volatile Eeprom memory.
Calibration Mechanisms	N/A (Multiple Echo Gauge)
Display & Recall Facilities	N/A
Display Response Time	500 ms
Printer Output	N/A
Environmental Rating	IP68 Rated to 300m (984 ft) continuous immersion in water.
Compliance	CE UKCA RoHS Compliant
Designed for	BS EN 15317
Battery Charger	Type 2115. Input Voltage: 100 to 240 V AC, 50 to 60 Hz, 0.35A. Output Voltage: 13 V (max) 0.6 A (max)

17. Topside Repeater Electrical Connections

Cygnus UNDERWATER Gauge to Topside Repeater Display Unit

Impulse Connector IE-LPMIL-4-MP (Gauge End)	Topside Repeater Lemo 1 (Topside)	Signal
Pin 1 (black)	-	No Connection
Pin 2 (white)	Pin 3 (yellow)	RS-422 : TX-
Pin 3 (red)	Pin 1 (grey)	GND
Pin 4 (green)	Pin 2 (green)	RS-422 : TX+

Cygnus UNDERWATER Gauge to USB-485 to Computer (CygLink)

RS-422 input signal connections to the USB-485 converter are made using a 9 way D-sub plug, shown below:

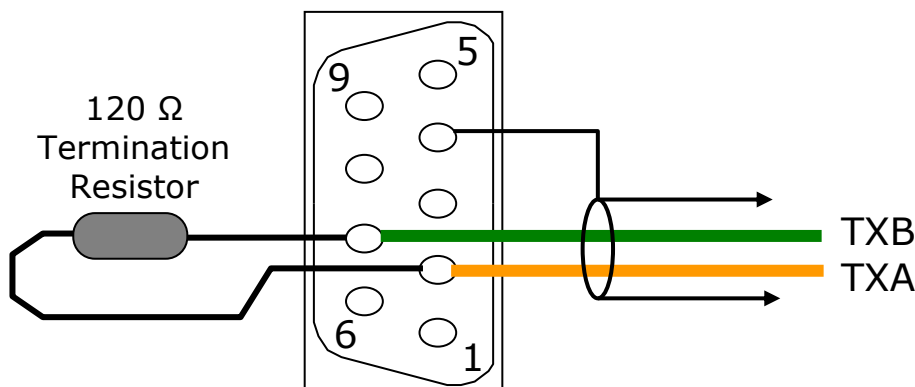

RS-422 Connections to Converter

Impulse Connector IE-LPMIL-4-MP (Gauge End)	RS-422 Converter 9 way D-sub Plug (Topside)	Signal
Pin 1 (black)	-	No Connection
Pin 2 (white)	Pin 2 (yellow)	RS-422 : A (TX-)
Pin 3 (red)	Pin 4	Shield (GND)
Pin 4 (green)	Pin 7 (green)	RS-422 : B (TX+)

18. Serial Data Format

The CygLink program is provided to automatically decode the measurement data sent from the Gauge, and to provide a calibrated display of the results. For users who want to display and log the data using their own software, this section describes the arrangement of the data sent from the Gauge.

Protocol

1. Differential RS-422 line drivers [TX+, TX-]
2. Unidirectional - Gauge is transmit only
3. Eight Data bits, 1 Start bit, 1 Stop bit, No Parity; 2400 baud
4. Four packets per second
5. *Valid-Reading* packet-length : 7 bytes
6. *No-Reading* packet-length : 3 bytes

Valid-Reading packet arrangement:

7 byte sequence:	
1	SOH [hex 01]
2	Status-byte
3	Data-byte 0
4	Data-byte 1
5	Data-byte 2
6	Data-byte 3
7	ETB [hex 17]

No-Reading packet arrangement:

3 byte sequence:	
1	SOH [hex 01]
2	Status-byte
3	ETB [hex 17]

Interpreting the Readings sent from the Gauge:

Decimal Point position	Decimal Point position is implied from the combination of Range, Resolution, and Units bits in the Status byte of each
------------------------	--

	Reading [see table above]
Range	The Gauge returns all Readings in a 4-byte decimal string Readings which require 5-bytes [e.g. 100.00+mm, or 10.000+inch] are auto-ranged to the 4 most significant bytes Range bit for every Reading must be read from the Status-byte
Resolution	The Gauge is factory set to Lo-Resolution setting: 0.1 mm, or 0.005 inch but may be changed by the user to Hi-Resolution setting : 0.05 mm, or 0.002 inch as required
Units	The Gauge has a default Metric Units-setting. The Units bit must be read from the Status-byte

Status-byte structure

Decodes into bit-fields:

bit 7 – ms	Cygnus Gauge Type	HI = Mark2+ [LO = Mark1 – not used]	[default]
Bit 6	Reading Resolution	HI = Hi-Resolution	[default]
Bit 5	Measurement Units	LO = Metric HI = Imperial	[default]
Bit 4	Reading Range	HI = Hi-Range	
Bits 3, 2	Echo Count	0 to 3 Echoes found	
Bit 1	Calibration	HI = Remote LO = Local	[default]
Bit 0 - ls	No-Reading flag	HI = No Reading LO = Valid Reading	

Data-bytes arrangement

The four data bytes are ASCII-encoded, decimal thickness value Data byte 0 is most-significant. Leading-zeroes are replaced by ASCII Space [hex 20]. Decimal points are implied from the Status-byte – Units, Resolution and Range bits:

Reading-type	Hi-Range	Lo-Range
Imperial, Lo-Resolution	x x . x x	x . x x x
Metric, Lo-Resolution	x x x . x	x x x . x
Imperial, Hi-Resolution	x x . x x	x . x x x
Metric, Hi-Resolution	x x x . x	x x . x x

19. Table of Sound Velocities

Velocities will vary according to the precise grade and processing conditions of the material being measured.



This table is included as a guide only.

Wherever possible, the Gauge should always be calibrated on the material under test.



These Velocities are given in good faith and are believed to be accurate within the limits described above.

No liability is accepted for errors.

Velocities given are the compressional wave velocity c_l .

Material	Velocity of Sound (V)		Conversion Factor (f)
	m/s	in/us	
Aluminium (alloyed)	6380	0.2512	1.078
Aluminium (2014)	6320	0.2488	1.068
Aluminium (2024 T4)	6370	0.2508	1.076
Aluminium (2117 T4)	6500	0.2559	1.098
Brass (CuZn40)	4400	0.1732	0.743
Brass (Naval)	4330	0.1705	0.731
Brass (CuZn30)	4700	0.1850	0.794
Copper	4700 - 5000	0.1850 - 0.1969	0.794 - 0.845
Grey Cast Iron	4600	0.1811	0.777
Inconel	5700	0.2244	0.963
Lead	2150	0.0846	0.363
Monel	5400	0.2126	0.912
Nickel	5630	0.2217	0.951
Phosphor Bronze	3530	0.1390	0.596
Mild Steel	5920	0.2331	1.000
Tool Steel	5870	0.2311	0.992
Stainless Steel 302	5660	0.2228	0.956
Stainless Steel 347	5790	0.2279	0.978
Tin	3320	0.1307	0.561
Titanium	6100 - 6230	0.2402 - 0.2453	1.030 - 1.052

Tungsten Carbide	6660	0.2622	1.125
Epoxy Resin	2500	0.0986	0.422
Acrylic	2730	0.1076	0.461
Nylon (Polyamide)	2620	0.1032	0.443

Reading Conversions

If only a few measurements are to be taken on a material other than Steel, it may be easier to leave the calibration set for Steel and merely convert the readings by multiplying by the **Conversion Factor** for the material being measured.

This method avoids unnecessary recalibration.

Example.

The Gauge is calibrated for Steel [5920 m/s], but the reading is being taken on Copper [4700 m/s] :

$$\begin{aligned}
 T &= t \times V_{\text{COPPER}} / V_{\text{STEEL}} \\
 &= t \times 4700 / 5920 \\
 &= t \times \underline{0.794}
 \end{aligned}$$

thus : **T = t x f** [where: f = $V_{\text{COPPER}} / V_{\text{STEEL}}$]

where : **T = true thickness of Copper being measured**
t = actual reading obtained
f = Conversion Factor (from table)
 V_{COPPER} = Sound Velocity in Copper : 4700 m/s
 V_{STEEL} = Sound Velocity in Steel : 5920 m/s

The **Conversion Factor f**: is given for various materials in the Table of Sound Velocities

20. Accessories List

Cygnus UNDERWATER Probes with 1 metre Lead

All probes are fully assembled and include a spare membrane pack and knurled ring locking key.

Part No.	Description
001-9340	Probe S2C 2.25MHz 13mm(1/2") for Cygnus Underwater
001-9341	Probe S2D 2.25MHz 19mm(3/4") for Cygnus Underwater
001-9357	Probe S3C 3.5MHz 13mm(1/2") for Cygnus Underwater
001-9343	Probe S5A 5.0MHz 6mm(1/4") for Cygnus Underwater
001-9342	Probe S5C 5.0MHz 13mm(1/2") for Cygnus Underwater
001-9320	Fixed Head Probe 2.25MHz 13mm (1/2") for Cygnus Underwater

Lower frequency probes offer better penetration on heavy corrosion/coatings. Please refer to page 59 for correct probe selection.

Probe Spares and Membranes

Polyurethane Membranes are for normal use on surface temperatures up to 75°C.

Teflon Membranes are for use on surface temperatures up to 150°C

Part No.	Description
001-3702	Pack of 20 Polyurethane Membranes for 6 mm (1/4") Probes
001-3701	Pack of 20 Polyurethane Membranes for 13 mm (1/2") Probes

001-3700	Pack of 20 Polyurethane Membranes for 19 mm (3/4") Probes
001-4873	Pack of 10 Teflon Membranes for 6 mm (1/4") Probes
001-4874	Pack of 10 Teflon Membranes for 13 mm (1/2") Probes
001-4875	Pack of 10 Teflon Membranes for 19 mm (3/4") Probes
001-3706	Membrane Couplant Bottle (25 ml)
001-3707	UCA-2 Ultrasonic Couplant Gel (1 litre tub)
001-3708	UCA-2 Ultrasonic Couplant Gel (100 ml)

Cables and Leads

Part No.	Description
001-0410	Calibration Jumper Lead for Cygnus 1 IS, UW & HD Gauges
001-0413	Cygnus UW (Impulse) to Topside PC (9D) Umbilical cable
001-0414	Cygnus UW (Impulse) to Topside Repeater (Lemo) Umbilical
001-0415	Umbilical cable for DIVE / UW / ROV to Topside (per metre)
001-0416	Topside Interface Cable A (Lemo socket) to B (9-way D plug)
001-0417	Topside Interface Cable B (9-way D socket) to A (Lemo plug)

Electronic Bodies Only

Part No.	Description
001-7179/4	Cygnus UNDERWATER Gauge Body only with TOPSIDE Connector
001-7181	Cygnus TOPSIDE REPEATER (Instrument Body)

Batteries and Chargers

Part No.	Description
001-1504	Battery for Cygnus UNDERWATER Gauges Mk 3/4
001-1514	Battery Charger for Cygnus UW / IS Mk 3/4 (UK Mains Plug)
001-1515	Battery Charger for Cygnus UW / IS Mk 3/4 (US Mains Plug)
001-1516	Battery Charger for Cygnus UW / IS Mk 3/4 (EU Mains Plug)

Miscellaneous Spares

Part No.	Description
001-2620	Nose Cone Torque Bar
001-4822	Lanyard for Cygnus UNDERWATER
001-4850	Steel Test Block 15 mm
001-4851	Steel Test Block 1/2"
001-4852	Coated Test Block
001-4856	Carbon Steel Step Block 5-25 mm in 5 mm steps set in perspex
001-8308	Isolated Data Converter RS422 to RS232 Model 'K3'
003-0422	RS232 to USB Serial interface cable
001-0419	Impulse Connector 4-Way Blanking Plug

Carry Case



Part No.	Description
001-4813-UW	Pelican Carry Case for Cygnus Underwater Gauge Kit (Yellow)

21. Topside Repeater Upgrade Options

Add Option A or B to a Cygnus UNDERWATER Gauge with Impulse Socket

The Impulse socket must be fitted to allow connection to topside repeater systems.



Part No.	Description
<p>001-7133A/4</p> 	<p>Option A: Topside Repeater Display Parts as follows:</p> <p>Cygnus Topside Repeater Display unit, 4-Way Impulse Connector with flying lead.</p>
<p>001-7133B/4</p> 	<p>Option B: Topside Computer Data-Logging Facility (CygLink) Parts as follows:</p> <p>'K3' RS232-RS422 Isolated Converter RS232 to USB converter 4-Way Impulse Connector with flying lead CygLink Software</p>

Please refer to page 28 for information on options A, B and C.

22. Recycling and Disposal (EC Countries)

The WEEE Directive (Waste Electrical and Electronic Equipment 2002/96.EC) has been put into place to ensure that products are recycled using best available treatment, recovery and recycling techniques to ensure human health and high environmental protection.

The Gauge has been designed and manufactured with high quality materials and components which can be recycled and reused. It may contain hazardous substances that could impact health and the environment. In order to avoid the dissemination of those substances in our environment and to diminish the pressure on natural resources we encourage you to dispose of this product correctly.



DO NOT dispose of this product with general household waste.

DO dispose of the complete product including cables, plugs and accessories in the designed WEEE collection facilities.

This product may also be returned to the agent or manufacturer who supplied it for safe end-of-life disposal.

23. Warranty Information

LIMITED THREE YEAR WARRANTY FOR CYGNUS ULTRASONIC THICKNESS GAUGES

1. Cygnus Instruments Limited ("CYGNUS") warrants that, subject as set out below, the Products manufactured by it (excluding consumables, batteries, probes, leads, microphones and telescopic extensions) will be free from defects in materials and workmanship for a period of three years from the date of purchase either from CYGNUS or from an Authorised CYGNUS Distributor. Batteries, probes, leads, microphones and telescopic extensions are warranted for 6 months. This warranty is limited to the original Purchaser of the Product and is not transferable. During the warranty period, CYGNUS will repair, replace or refund, at its option, any defective Products at no additional charge, provided that the product is returned by the original Purchaser, shipping prepaid, to CYGNUS or an Authorised CYGNUS Distributor. If shipped by mail or any common carrier, the Purchaser must insure and accept all liability for loss or damage to the Product and must use shipping containers equivalent to the original packaging. Replacement products or parts will be furnished on an exchange basis only. All replaced products or parts become the property of CYGNUS.
2. Any defects in materials or workmanship must be notified to CYGNUS by the Purchaser within seven days after the discovery of the defect or failure.
3. Dated proof of purchase must be provided by the Purchaser when requesting warranty work to be performed or making any other claim under this warranty. CYGNUS will not be liable under this warranty unless the total price for the Product was paid by the due date for payment.
4. This warranty does not extend to any products which have been damaged as a result of, accident, misuse or abuse, natural or personal disaster, service, modification or repair by anyone other than CYGNUS or an Authorised CYGNUS Service Centre, failure to properly store or maintain the Product, negligence, abnormal working conditions, fair wear and tear, or failure to follow the instructions issued by CYGNUS in relation to the Product.
5. Except as expressly set forth above or in the CYGNUS Terms of Sale, subject to which the Products were purchased, all warranties, conditions or other terms implied by Statute or Common Law are extended to the fullest extent permitted by law.
6. Except in respect of death or personal injury caused by the negligence of Cygnus, Cygnus shall not be liable to the Purchaser or to any other person by reason of any representation (unless fraudulent), or any implied warranty, condition or other term, or any duty at common law, or under the express terms of the contract for purchase of the Products, for loss of profit or for any indirect, special or consequential loss or damage, costs, expenses or other claims for compensation whatsoever (whether caused by the negligence of Cygnus, its employees or agents or otherwise) which arise out of or in connection with the supply of the Products or their use or resale by the Purchaser or by any other person. The entire liability of Cygnus under or in connection with the Products shall not exceed the price paid for the Products, except as expressly provided in this warranty.

24. Pressure Test Statement

All Cygnus UNDERWATER gauges are pressure tested in water as part of our test procedures.

Please refer to the environmental rating section for further information

25. Index

Accessories

- Batteries and Chargers, 84
- Cables and Leads, 83
- Carry Case, 84
- Electronic Bodies, 83
- Membrane Couplant, 83
- Miscellaneous Spares, 84
- Probe spares and membranes, 82
- UCA-2 Ultrasonic Couplant Gel, 83

Automatic Power Off, 22

Batteries

- Charge Indicator, 26
- Charging, 26
- Life, 25
- Low Battery Warning, 25

Battery Pack

- Fitting, 15

Calibration, 62

- Conversion Factor, 81
- Jumper Lead, 61
- Single Point, 63
- Velocity of Sound, 64

Cleaning, 72

CygLink

- COM Port, 35, 51
- Drivers, 35
- Logging, 43
- Requirements, 34

Deep Coating, 74

Disposal, 87

Echo Strength, 23

Gauge Controls, 21

Gauge Menu, 60

Imperial, 65

Impulse Connector, 21

Lanyard, 20

Metric, 65

Nosecone

- Fitting, 16
- Removing, 16

O-Rings

- Checking, 19
- Replacing, 17

Pitted surface, 68

Power button, 22

Probes

- Frequency, 67
- Knurled Ring, 58
- Locking Ring Key, 58
- Membrane Couplant, 58
- Polyurethane Membrane Membrane, 57
- Selection, 57
- Specifications, 59

Problems, 73

Pulse-echo, 9

Recycling, 87

Repair, 73

Resolution, 66

Rough surfaces, 68

Service, 73

Sound Velocities, 80

Specifications, 80

Test block, 62

Thickness Measurement, 23

Tommy Bar, 16

Topside Repeater, 28

- Automatic Display Backlight, 30

- blinking plug, 56

- Display Units, 30

- HOLD, 30

- LCD display, 29

- maximum cable length, 28

Topside Repeater Upgrade
Options, 85
Triple Echo Verification, 9
Troubleshooting, 69
Umbilical Cable

maximum cable length, 28
Units, 65
Unrelated echoes, 69
Warranty, 88
WEEE Directive, 87