

Cygnus MINI ROV Mountable and Topside Repeater Systems

Operation Manual and Accessories List

Doc No. M4-CYGMINI-TSR-M-ENG_Iss 5
August 2019
(Mk4 Cygnus MINI ROV Gauges)

Contents

1. Introduction.....	6
CYGNUS MINI ROV Mountable Ultrasonic Thickness Gauge	6
Multiple Echo Measurements	7
Triple Echo Verification	7
Cygnus Instruments.....	8
2. Gauge Kit Contents	9
Data Conversion Items	10
Top Side Repeater (TSR) Remote Display Unit with Video On-Screen-Display (OSD)	11
3. Gauge Preparation	12
Fitting the Probe-module	12
Underwater Cable connection to the Gauge.....	13
Electrical connections to the Gauge	14
Power Supply	14
Data Output.....	14
Electrical connections to the Surface.....	15
Connection to a Computer.....	15
Connection to the ROV Craft.....	15
Custom Connection	15
Custom Display Software	15
Measuring Through a Water Gap	16
4. Displaying the Thickness Measurements.....	17
Data Logging	17
Video Overlay	17
5. Calibration	18
6. Using the TSR Remote Display Unit.....	19
Turning the Unit On	19
Changing the Displayed Units	19
Setting the Velocity of Sound	19
Calibrating to a Known Thickness using a TSR.....	20
Display Hold Function.....	20
Automatic Display Backlight	20
Video Overlay Facility	20
Connecting the Video Signal	21
Positioning the On-Screen Display (OSD).....	21
Testing the Link.....	22

Troubleshooting - Error Messages	22
7. CygLink Surface Display and Control Kit	23
Kit Contents.....	23
Connection Diagram.....	24
Connector Details and Signals	24
Installing CygLink	24
COM Port Numbers	25
Setting the COM Port Manually	25
Finding your COM Port Number	25
To Change the COM Port number assigned by Windows®	26
Opening Device Manager.....	26
Running CygLink Application.....	28
Connecting to the ROV Gauge.....	28
Changing Gauge Settings.....	29
Material Velocity List	29
Calibrating to a Known Thickness using CygLink	30
CygLink Surveys and Data Logging.....	31
Editing the Survey Details	32
Editing the Survey Group Details	32
Reference and Minimum Thickness Criteria	33
Producing a Survey Report Document	33
Logging Measurements Directly in CygLink	33
Pre-Set Measurement Comments List.....	33
Adding Comments or Notes to a Measurement.....	34
CygLink Trouble Shooting	35
Connection Problems – USB Drivers	35
Wiring Problems	35
8. Probes & Membranes	36
Probe Selection	36
Changing the Membrane	37
Probe Selection & Specifications.....	38
Probe Frequency Identification.....	38
Mounting the Ultrasonic Probe	39
9. O-Ring Seals	40
Correct fitting of O-ring seals	40
Removing the Nosecone	41
Replacing the O-Ring Seals	42
Checking the O-rings.....	42
10. General Points on Thickness Gauging	44

11. Troubleshooting	45
Difficulty obtaining a Reading	45
If Readings are Erratic or Unstable	45
12. The 3 Point Check	46
13. Care and Servicing	47
Cleaning the Gauge	47
Use of O-Rings	47
Data-link connector	47
Environmental	48
Repairs	48
Returning the Gauge for Servicing	48
14. Information	49
Technical Specifications	49
15. Serial Data Format	50
Protocol	50
Valid Thickness Measurement Packet Arrangement	50
No Thickness Measurement Packet Arrangement	50
Status-byte Structure	51
Data-bytes Arrangement	51
Interpreting the Readings sent from the Gauge	52
16. Table of Sound Velocities	53
Reading Conversions	54
17. Part Number & Accessories List	55
Software	55
Underwater Probes with 1 Metre Lead	55
Probe Spares and Membranes	56
Knurled Rings	57
Cables and Leads	57
Electronic Bodies Only	57
Miscellaneous Spares	57
18. Recycling and Disposal (EC Countries)	59
19. Warranty Information	60
20. Pressure Test Statement	61
21. Independent Cable Connection	62
Recommended cable connection for direct cabling from Cygnus MINI ROV Gauge to surface computer	62
22. ROV-Local Termination Connection	63

Recommended cable connection from Cygnus MINI ROV Gauge to ROV craft 63

Recommended connection at surface, taken from ROV cabling to computer 64

23. Index 65

1. Introduction

CYGNUS MINI ROV Mountable Ultrasonic Thickness Gauge

The ***Cygnus MINI ROV Mountable Ultrasonic Thickness Gauge*** (Cygnus MINI ROV Gauge) is designed for high-reliability thickness measurement using the Multiple-Echo technique. The Gauge is a lightweight gauge designed to be mounted on smaller submersible ROV craft.

Fully-waterproof, the Cygnus MINI ROV Gauge can be used both underwater and in air and is pressure tested to 500 metres' water depth. It is supplied with dedicated PC-software for displaying and logging thickness readings at the surface.

The Gauge is supplied with one ultrasonic Probe. The Probe type must be specified at the time of purchase of the Gauge. Probes are not freely interchangeable – please consult with *Cygnus* if you wish to use a different Probe with the Gauge.



The Gauge is a solid-state electronic instrument which, under normal operating conditions, will give many years of active service.

Although designed for ease of operation, first time users should carefully read this manual to familiarise themselves with the features of the Gauge.

Multiple Echo Measurements

The Gauge works on the pulse-echo principle. The Probe transmits a very short pulse of ultrasound which enters the test piece. The Probe then acts as a receiver listening for return echoes, converting them into electrical signals which are processed to produce timing information that can be used to determine the material thickness.

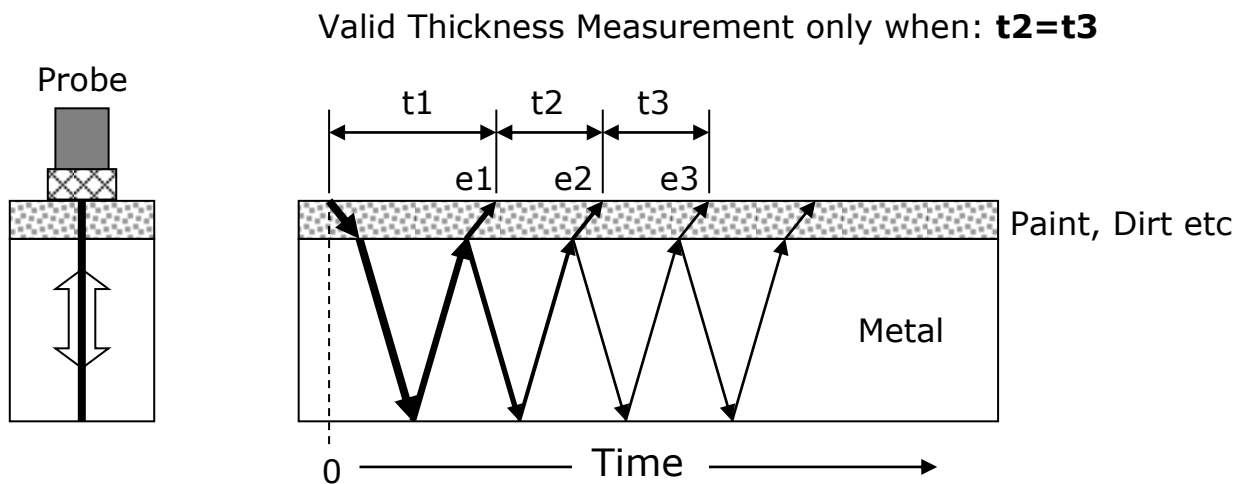

The *multiple-echo* beam travel is depicted above, spread out in time, to illustrate the timing method. In reality the beam path is straight and perpendicular to the surface as the ultrasonic energy reverberates up and down within the metal (shown on the left). Each time an echo is reflected back down, a small portion of the energy comes up through the coatings and is detected by the Probe which acts as a receiver (e1, e2 and e3).

The delay between echoes at the Probe-face (t2 and t3) is exactly equal to the time taken to pass through the metal twice, therefore coatings such as paint are ignored and the measurement displayed is the metal thickness only.

Triple Echo Verification

The Gauge requires 3 equi-spaced return echoes in order to calculate a thickness measurement value (t2=t3). This method ensures the Gauge only displays valid thickness values, the three echoes provide a reliable method of signal verification. This process is referred to as Triple Echo Verification.

Cygnus Instruments

Cygnus Instruments Limited, founded in 1983, pioneered the development of the Digital *Ultrasonic Multiple-Echo Technique* used for measurement through coatings. This has long since been the standard required to ensure that accurate measurements are taken without the need to zero the Gauge or remove any coatings first.

Our philosophy is to work closely our customers to provide high quality products, engineered to serve heavy industry & harsh environments. Cygnus Ultrasonic thickness gauges are designed to be reliable and simple to use. We have an unrivalled reputation in over 45 countries around the world.



CYGNUS Instruments Ltd.

Cygnus House, 30 Prince of Wales Road,
Dorchester, Dorset, DT1 1PW England.
Website: www.cygnus-instruments.com
Tel: 00 44 (0) 1305 265533
Fax: 00 44 (0) 1305 269960
sales@cygnus-instruments.com

Cygnus UAE Cygnus Instruments Middle East

P.O. Box 127267
Jebel Ali Free Zone (JAFZA)
Dubai
UAE
Website: www.cygnus-instruments.com
Telephone: +971 50 3459305
E-mail: sales@cygnus-instruments.com

CYGNUS Instruments Inc.

Phillips Hwy Commerce Park
6900 Phillips Hwy, Suite 8
Jacksonville, FL 32216
Tel: 00 1 410 267 9771
Fax: 00 1 410 268 2013
www.cygnusinstruments.com
sales@cygnusinstruments.com

CYGNUS Singapore (S) Pty. Ltd.

63 Jalan Pemimpin #05-01,
Pemimpin Industrial Building.
577219 Singapore.
Tel : (+65) 6252 5909
Fax : (+65) 6251 1318
www.cygnus-instruments.sg
sales@cygnus-instruments.sg

2. Gauge Kit Contents

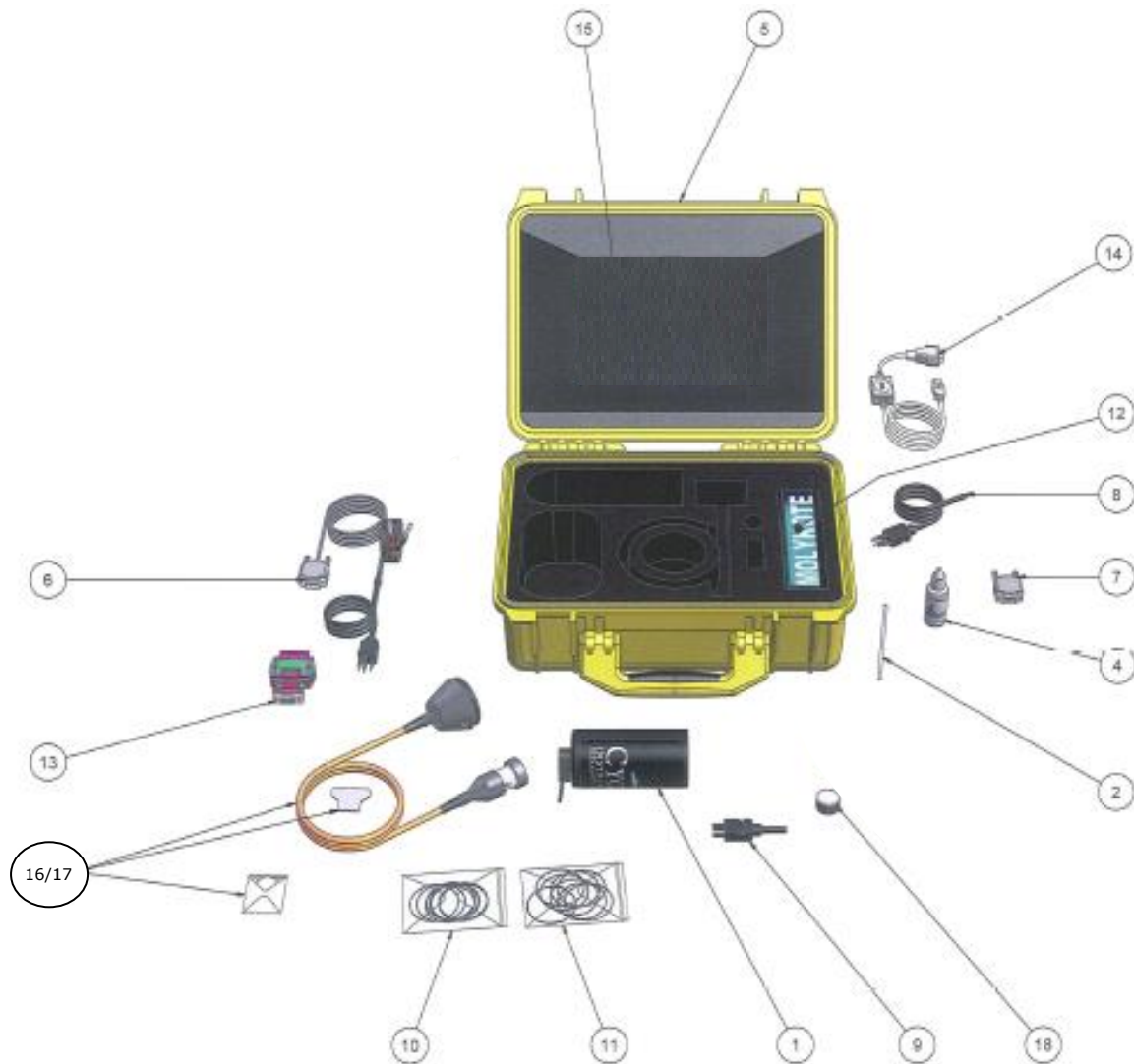

1. Cygnus MINI ROV Gauge Body
2. Nose Cone Torque Bar
3. Operation Manual & CygLink Software on USB Flash Drive (Not Shown)
4. Bottle of Membrane Couplant
5. Carry Case
6. Test Lead
7. 9 Way D-Type Connector
8. Impulse Plug to Fly Leads
9. Impulse Blanking Plug

10. 10 x 'B/D' O Rings
11. 10 x 'A' O Rings
12. Silicone Grease
13. K3 RS-422/485 to RS-232 Converter
14. RS-232 to USB Converter
15. K3 Manual, Documents and Warranty Letter
16. Probe Assembly, including:
17. Spare Membranes and Membrane Key
18. Sample Test Block

Data Conversion Items

Connection to USB is an RS232-to-USB Adaptor, as included in the main kit contents. This USB-to-Serial Adaptor is used together with the RS422-to-RS232 Converter as shown:

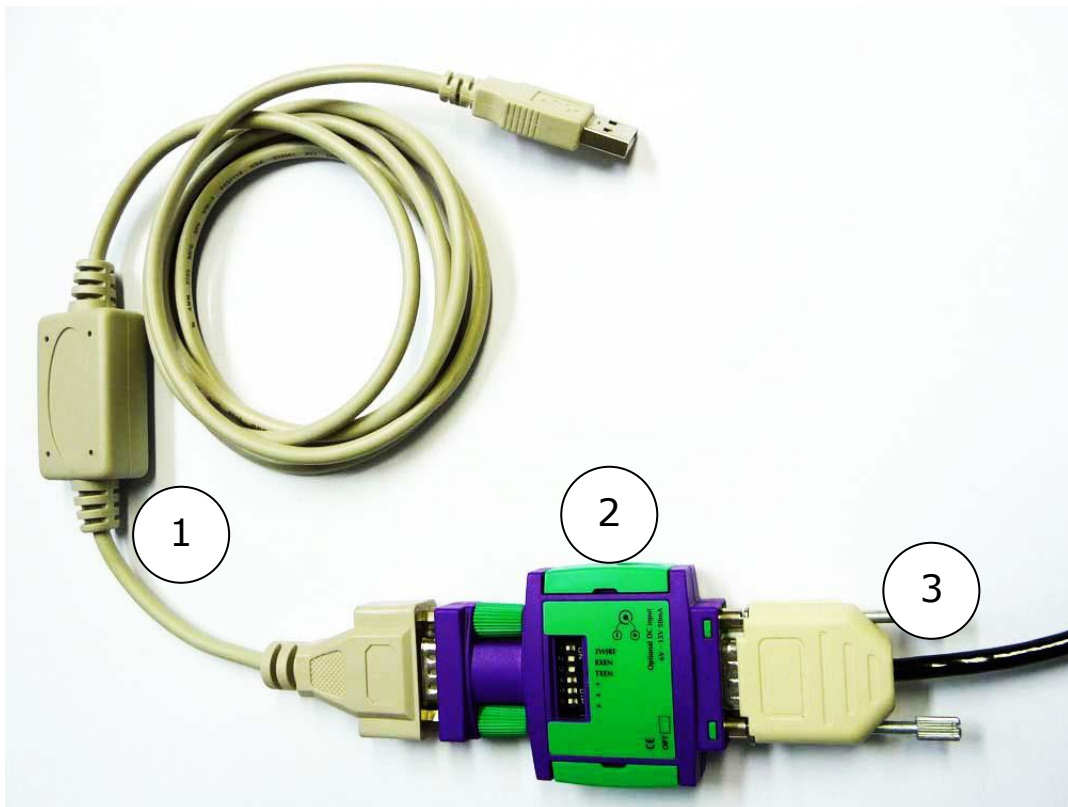

1. RS-232 to USB Converter Module & Cable
2. 'K3' RS-422/485 to RS-232 Converter Module
3. Connection from ROV subsea link

Top Side Repeater (TSR) Remote Display Unit with Video On-Screen-Display (OSD)

The Cygnus TSR Display unit with OSD is an *Optional Accessory* to the main Gauge Kit.



It is supplied with:

1. Protective silicone sleeve
2. 12V DC power supply UK/EU/US
3. BNC to BNC cable x 2
4. BNC Jack to Phono plug
5. BNC Plug to Phono socket
6. 9-way D to Lemo link lead

3. Gauge Preparation

The Gauge is supplied ready to use, once the probe-module has been attached to it. All that is required is to make the necessary electrical connections between the Gauge and the ROV Craft and the chosen topside display.

There are no controls or display on the gauge. Calibration is performed at the surface using the top side display.

Fitting the Probe-module

The "Probe-module" consists of a nosecone, an integral length of underwater coaxial cable and the probe itself. It is attached by screwing the nosecone section on to the end of the Gauge body, hand tight.

! Do not use the nosecone Torque Bar to tighten the nosecone. See page 41.

There is an O-ring seal ('A') fitted to the nosecone and another ('B') fitted to the Gauge body. Cover both O-rings with a light coating of *Silicone grease* and fit strictly as shown:

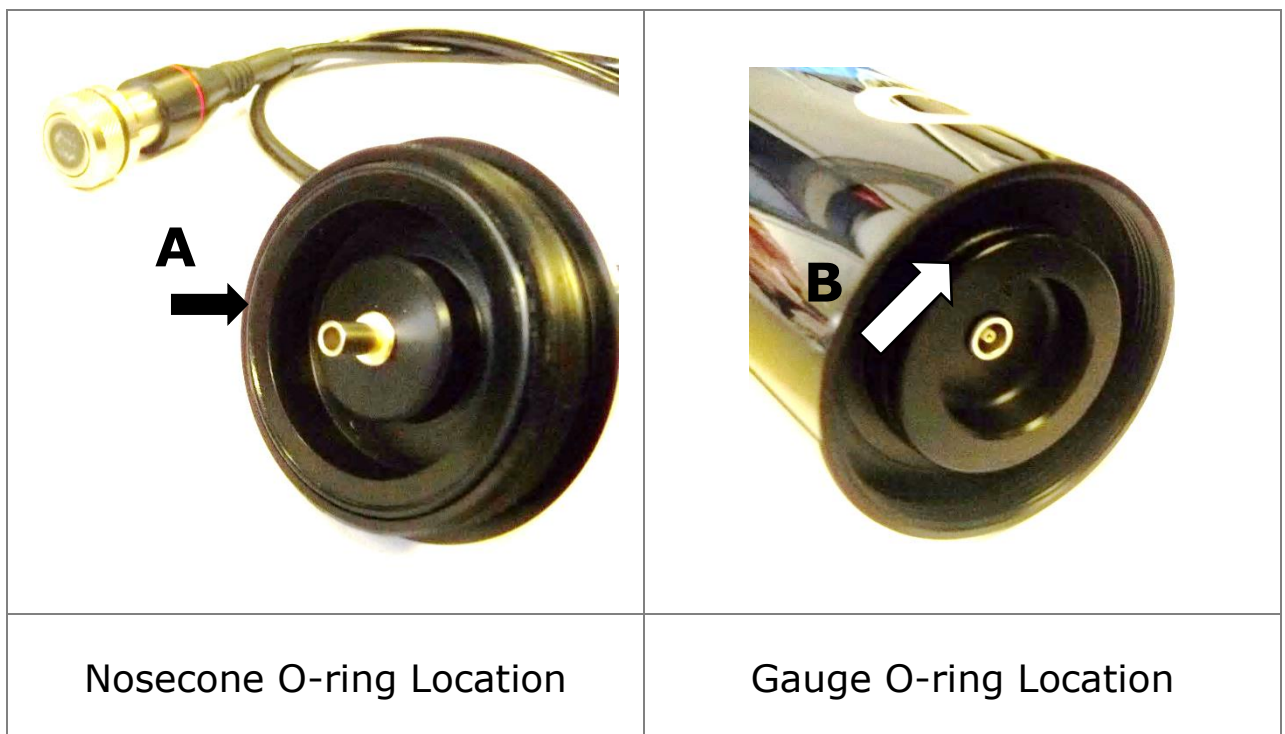

- !** It is important to ensure that the O-Rings are properly located. Incorrect fitting of O-rings, as shown below, will result in the instrument leaking.



- !** Both O-Rings must be replaced after every job or submersion. See page 42.

Underwater Cable connection to the Gauge

The Cygnus MINI ROV Gauge is provided with a fully-waterproof external ("Impulse") cable connection. To maintain the integrity of the electrical operation and watertight-seal it is essential that these precautions are observed:

⇒ Cable connection should only ever be made in *dry, ambient conditions* at the surface.

- !** Connections must never be made, or broken, underwater

⇒ Both the male underwater cable Connector and the Blanking-plug should have Silicone grease smeared on the pins before inserting into the female socket-connector on the Gauge

⇒ The male plug-connector should be pushed fully into the female socket-connector, and then the *rubber retaining-loop* should be pushed into the groove on the male-connector to complete the fully-waterproof connection



 A Blanking-plug is supplied for use: For safety we recommend that the Blanking Plug is fitted at *all times* when there is no cable attached to the Gauge body

Electrical connections to the Gauge

See pages 62, 63 & 64 for schematic connection details.

Power Supply

The Gauge requires a DC supply voltage between 7.5 and 30 volts. There is an internal 1 amp fuse and crowbar circuit to protect the instrument from over-voltage surges. The supply input is also protected against accidental reverse polarity connection.

There is no ON/OFF switch. The Gauge will operate continuously whilst power is connected. There will be an initial delay of about 2 seconds, and then the instrument will begin continuously transmitting thickness-measurement data.

A "Test-Cable" is supplied in the main Gauge Kit, which can be used to verify the Gauge operation. If you are using the Test-Cable, connect Red to positive and Black to negative.

Data Output

The Gauge outputs its status and thickness measurements as RS-422 serial data. The RS-422 output option can transmit the serial data up to 1200 m (4,000 ft) along a twisted pair cable. The serial

output drivers have ESD protection to ± 15 kV. See Serial Data Format on Page 50.

Electrical connections to the Surface

Connection to a Computer

A single “umbilical” cable can connect the Gauge to the surface, independent of the ROV craft’s own cabling. See page 62. This has a maximum length of 1000 metres. This cable can be supplied, on request, by Cygnus.

As shown on page 9, assemble the data conversion items:

- ⇒ 9-way D-connector (on the umbilical cable) to the K3 interface adapter (at the end marked RS422)
- ⇒ the other end of the K3 (marked RS232) can either connect to a free RS-232 serial port on your computer or to the Serial-to-USB adaptor, which can connect to a spare USB port on your computer.

Connection to the ROV Craft

In this method the connection from the Gauge is taken to the ROV craft itself and is merged with the ROV’s own cabling to connect to the surface. See pages 63 and 64.

Power for the Gauge can be taken from the ROV’s own power supply, if suitable.

It is essential that the data connections from the Gauge are maintained throughout as twisted-pair.

 If the distance from the Gauge to the surface is greater than 1000 metres the Data-output from the Gauge must be electronically buffered within the ROV.

Custom Connection

If you intend to convert the serial data sent from the Cygnus MINI ROV Gauge using *your own electronics*: the TX+ / TX- data-pair may be connected directly to any RS-422 compatible receiving equipment.

Custom Display Software

For Users who wish to develop *their own display software*: the format of the data sent from the Gauge is detailed in Serial Data Format, page 50.

Measuring Through a Water Gap

In ROV applications the water can be considered to be a coating. Thus it is possible to measure steel thickness through a small water gap between the probe and the material under inspection. As the Velocity of Sound for seawater is approximately 1500m/s this equates to a maximum seawater gap of 1.3mm.

4. Displaying the Thickness Measurements

The Gauge transmits thickness measurement data to the surface as serial data. To display the thickness value and provide a means of calibration, two options are provided:

1. Using a Cygnus Top-Side Repeater (TSR) unit
2. Using a computer with CygLink software

It is also possible for a third party application to read the serial data and process the thickness measurement data. For more information on the Serial Data Format, to enable use of your own software, see page 50.

Data Logging

The CygLink software also provides the facility to Data Log the thickness measurements as they are taken and to generate a report document for the survey.

Video Overlay

The optional TSR unit has a Video Overlay or On-Screen Display facility where the thickness measurements can be superimposed on to a video signal feed before the monitor and/or video recorder. The video overlay will work with PAL or NTSC video signals.

5. Calibration

The Gauge is supplied tested and calibrated. The Gauge will have been calibrated to measure thickness through steel (grade S355JO).

Either a 15mm or ½" test block is supplied with the kit so the Gauge can be quickly checked for correct operation. Note, this test block is not intended to be used for calibration of the Gauge and may not indicate an exact 15.00 mm.



The best way to calibrate the Gauge is to calibrate using a Known Thickness of a sample piece of the material you intend to measure. This method determines the velocity of sound for the material sample, which will always be more accurate than using a 'general' velocity value.

For calibration instructions using CygLink see Calibrating to a Known Thickness using CygLink on page 30, or with the TSR see Calibrating to a Known Thickness using a TSR on page 20.

If there is no test sample available the Gauge can be calibrated by setting the Velocity of Sound directly. A table on page 53 lists common materials and their velocity of sound values. For instructions on setting the velocity of sound using CygLink see page 30, or with the TSR see page 19.

A third method is to leave the Gauge set to its factory-preset value for Steel [5920 m/s or 0.2332 in/us], and then use a Conversion Factor from the table of velocities on page 53.

6. Using the TSR Remote Display Unit

The Cygnus Top Side Repeater (TSR) is a small handheld display unit that can display the thickness measurement values from the Gauge on its LCD display. It provides the ability to calibrate the Gauge's output to suit the material or to a specific velocity of sound. A video overlay facility is also included, which allows the thickness measurements to be superimposed on to a video signal before the monitor or video recording device.

Turning the Unit On

1.	Press the red ON key
2.	The Cygnus Logo screen appears
3.	If not connected to a Gauge the display shows "NO CONNECTION" <u>This is normal</u> – it just means no data has being received yet

Changing the Displayed Units

1.	Press the MENU key to display the MENU
2.	Press the DOWN ARROW key to scroll down to UNITS the current units are displayed
3.	Press the EDIT key to toggle between mm and Inch

Setting the Velocity of Sound

The velocity of sound value is displayed at the top of the screen in either m/s or inch/us.

1.	Press the MENU key to display the MENU
2.	The VELOCITY menu option should be selected at the top
3.	Press the EDIT key to adjust the velocity of sound value Press the OK key to save and exit

Calibrating to a Known Thickness using a TSR

The TSR display can be calibrated to a known thickness by using the Gauge to measure a sample of the material that will be measured. This method ensures the velocity of sound is set for the actual material being measured rather than using a “generic” value.

1.	Place and <u>hold</u> the Gauge’s ultrasonic probe on the material sample, <i>using couplant if out of the water</i> You should have a stable thickness measurement on the display
2.	Press the MENU key to display the MENU
3.	The CALIBRATE menu option should be selected at the top
4.	Press the EDIT key to adjust the measurement value to the known thickness of the sample being measured Press the OK key to save and exit
5.	Repeat from step 1 to check the calibration is stable.

Display Hold Function

The middle key HOLD can be used to freeze the display and hold the current thickness measurement.

1.	Press the HOLD key to freeze the display
2.	Press the HOLD key again to un-freeze the display

Automatic Display Backlight

The display backlight automatically turns off in bright light conditions, it will automatically turn on when the ambient light level drops.

Video Overlay Facility

The TSR can superimpose the thickness measurement on to a video signal to display it on the monitor screen, and also on the

video recording of the survey. This provides a thickness measurement that can be linked to a position or place in the video.

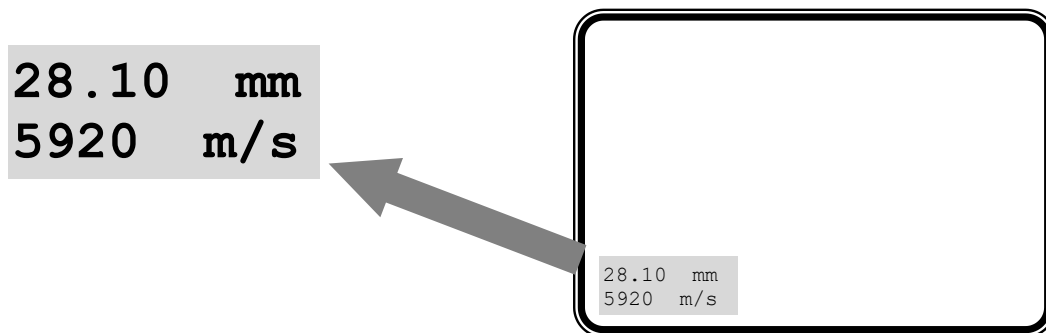

Connecting the Video Signal

The TSR has two BNC sockets on its top panel; Video In and Video Out. The video feeds to the monitor and video recorder is fed through the TSR. The TSR will automatically detect and adjust for PAL or NTSC video signals, it will work with colour or monochrome images.

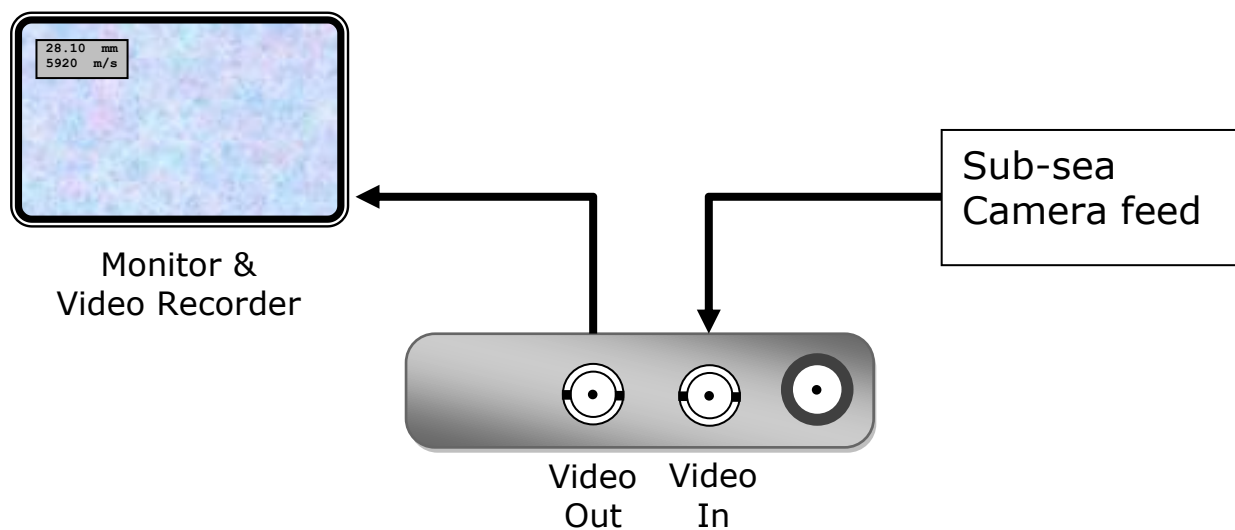

Positioning the On-Screen Display (OSD)

Because there is usually other information displayed on the video screen the TSR has the facility to move the thickness measurement display 'box' anywhere on the screen using X, Y coordinates. The position selected will be stored in the TSR memory during power off.

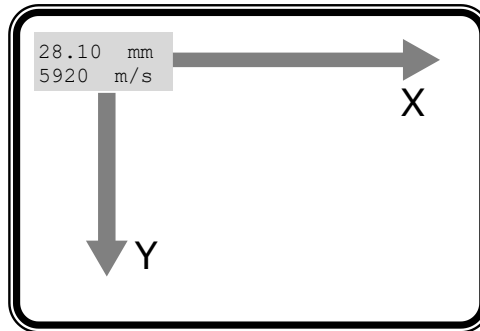

1.	Press the MENU key to display the MENU
2.	Press the DOWN ARROW key to scroll down to OSD X POS
3.	Press EDIT to adjust the X screen position Press EXIT to save and exit
4.	Press the DOWN ARROW key to scroll down to OSD Y POS
5.	Press EDIT to adjust the Y screen position Press EXIT to save and exit
6.	Press EXIT again to exit the menu screen

Testing the Link

Before use on a job it is recommended to test the link between the Gauge and the TSR. To do this simply power on both the TSR display and the gauge then measure the test block – the TSR should display the correct test block thickness.

Troubleshooting - Error Messages

1.	NO CONNECTION	<p>The TSR has not received any valid data since power-up</p> <p>Check that the Gauge is turned-on and displaying either a measurement or the echo strength bar-chart</p> <p>Check all cable connections are secure</p>
-----------	------------------	---

7. CygLink Surface Display and Control Kit

CygLink is a Windows® application for PCs that allows remote viewing, control and data logging for the Cygnus MINI ROV gauge. The software can provide the following functionality:

1. Surface display of thickness measurements
2. Remote setting of the velocity of sound
3. Remote setting of the units
4. Data Logging of thickness measurements into a Survey report

It should be noted that although Cyglink supports A-Scan, the Cygnus MINI ROV Gauge does not.

Kit Contents

The CygLink kit comprises the following items:

1. USB-RS485/RS422 Converter Cable
2. CygLink Software Installer on USB Flash Drive

You will also need an Umbilical cable and connectors to connect the Cygnus MINI ROV Gauge to the top side. Cygnus can supply the complete umbilical cable with connectors fitted, or the customer can make their own umbilical cable using connectors supplied with cable tails/flying leads.

Connection Diagram

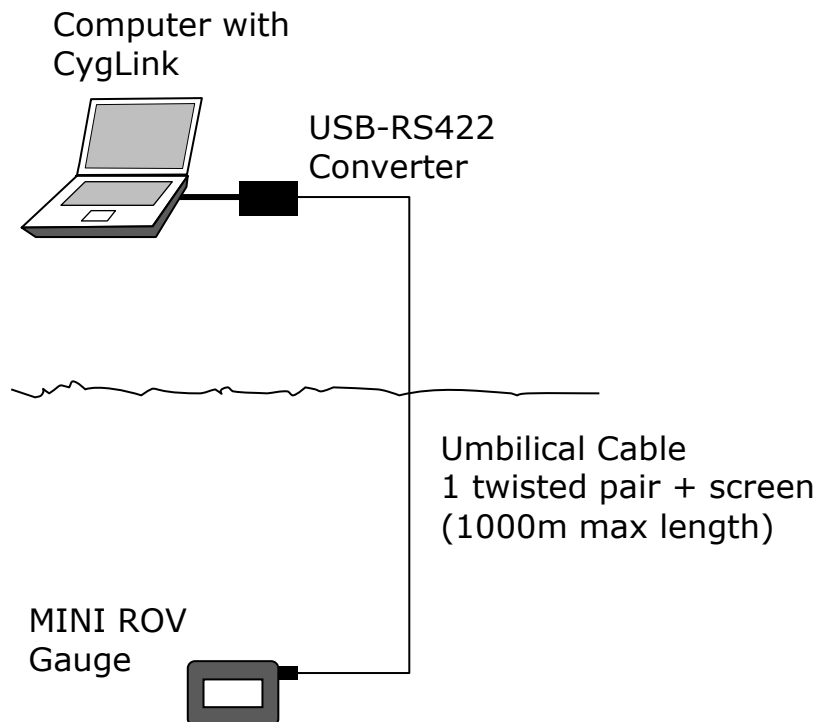

Connector Details and Signals

See page 62 for wiring details.

Installing CygLink

CygLink is supplied on a USB Flash Drive or can be downloaded from a web link emailed from Cygnus Instruments. Installation of CygLink follows normal software installation conventions after running the setup.exe program and following instructions.

To install from a flash drive, connect it to a free USB port on your computer. Navigate to the flash drive in Windows[®] Explorer and open the folder present in the root of the drive. Run the application named setup.exe to begin the installation process. You will need to accept the End User Licence Agreement in order to complete the installation and a summary of its terms is provided at the start. We advise opting for the Typical setup option for the smoothest installation experience.

COM Port Numbers

CygLink should automatically find the COM port number assigned to the USB converter when you click “Connect”, “Discover New Gauge and Connect” so you don’t need to search for the port number Windows has assigned.

Setting the COM Port Manually

If CygLink fails to locate the correct COM port number you can set in manually from the **File -> Communications Options** menu item. Just tick the **Manual Setup** box and select the correct COM port number.

Finding your COM Port Number

With the USB-RS485 Converter plugged into your computer, open Windows Device Manager – to do this press the Windows[®] key and the ‘**R**’ key together, then type “**devmgmt.msc**” into the prompt followed by enter key. In the **Ports** section, look for the USB Serial Port entry. Remember the COM number listed, as this will need to be selected within CygLink’s settings menu.

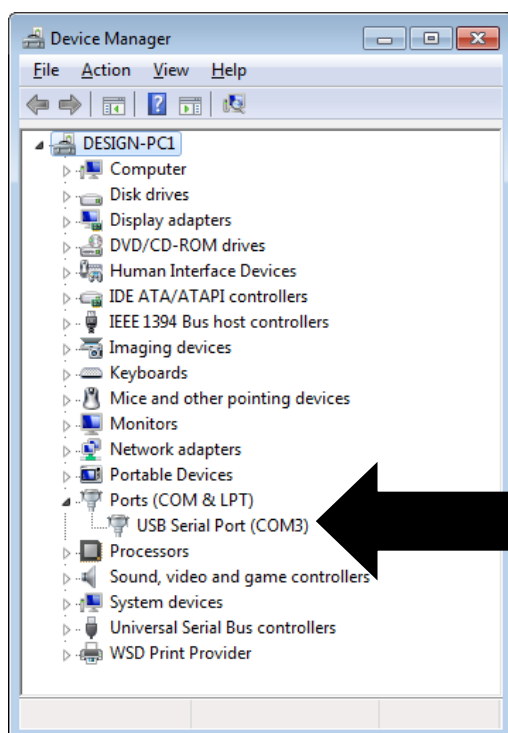

Windows[®] Device Manager

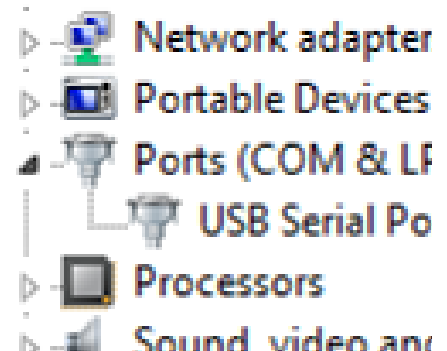

To Change the COM Port number assigned by Windows®

Depending on a variety of factors, Windows® may sometimes assign a COM Port number that is too high or unusual to be easily remembered. You may change the number assigned to the port by following these steps:

Opening Device Manager

Each version of Windows has a slightly different procedure for opening Device Manager. The most direct route is to press **Windows** + R, type "devmgmt.msc" and press Enter.

- Select the "**USB Serial Port**" device and right click to display its context menu, Click "**Properties**".

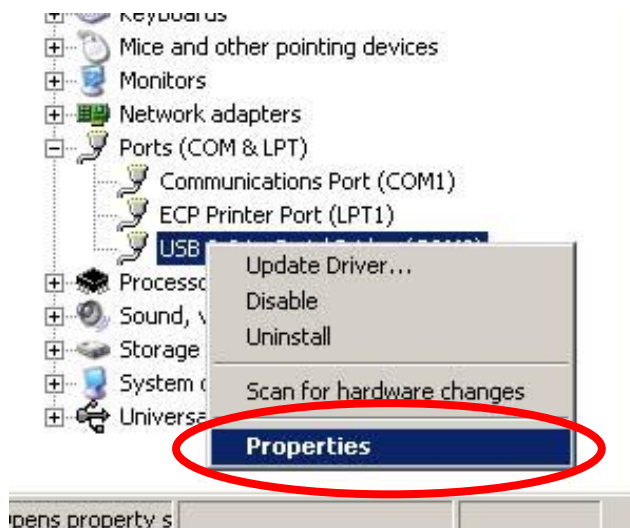

- On the Properties form select the "**Port Settings**" tab, then click the "**Advanced**" button.

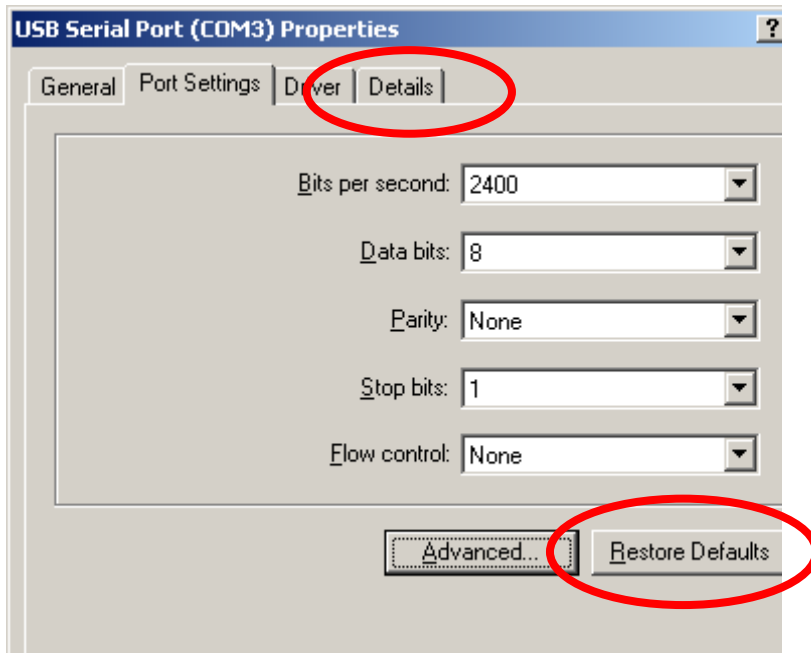

- On the “**Advanced Settings**” form you can change the COM Port number. Finish by clicking the “**OK**” button.

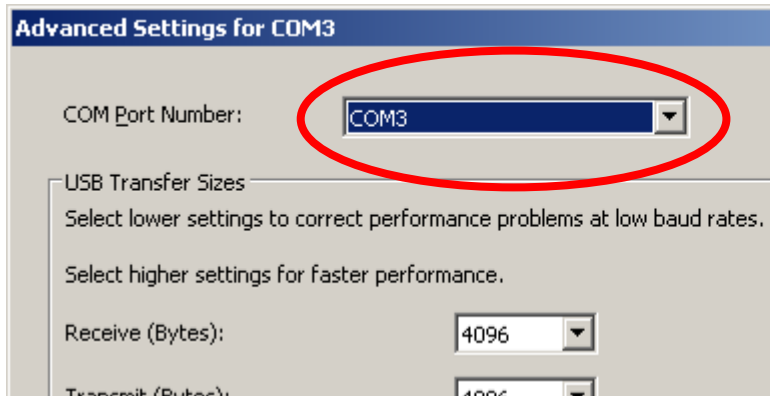

Running CygLink Application

Once installed CygLink will place shortcuts in the start menu and on the desktop. Click either to start CygLink. You are first asked to either **Create New Survey**, **Open Survey** or **Continue** - choose **Continue** to proceed without a Survey loaded.

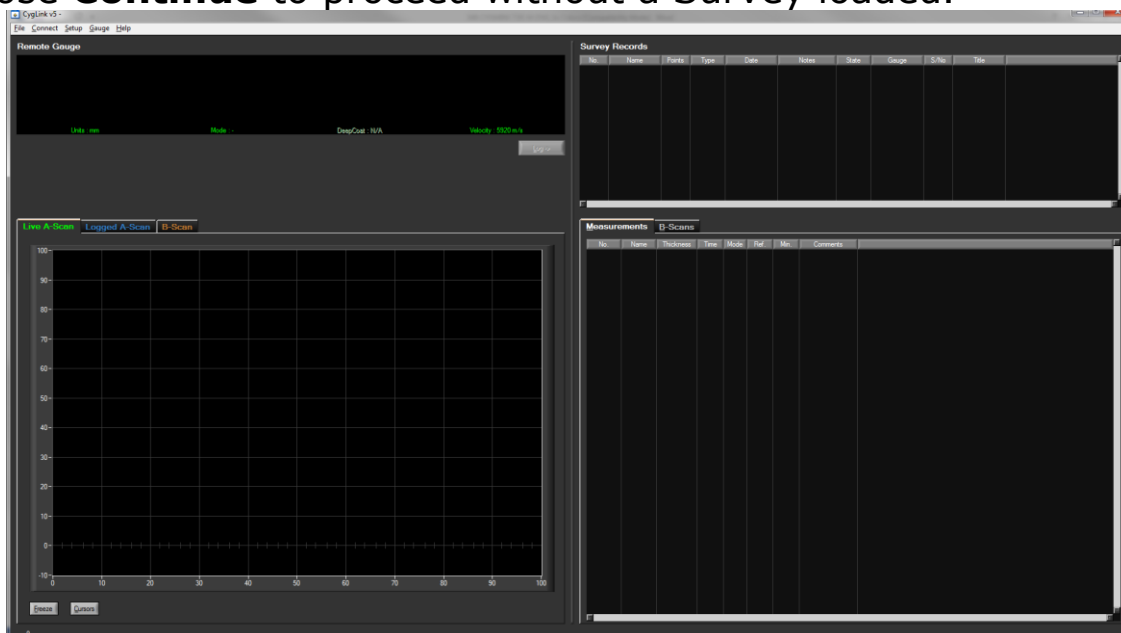

CygLink Main Screen with No Connection

Connecting to the ROV Gauge

To connect to the ROV gauge, assuming the gauge is connected and turned on, from the menu click **C**onnect then **D**iscover New Gauge and **C**onnect

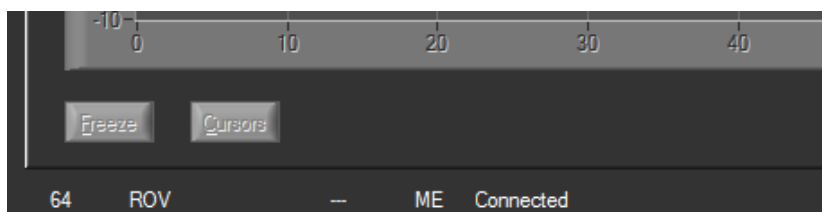

Bottom Left of CygLink Main Screen with Connection to Gauge

The Connection Status is shown in the status bar at the bottom left. Shown in the status bar are:

- An incrementing number
- The Gauge type (M4-ROV)
- The Echo Mode (Multiple Echo)
- Connected

Changing Gauge Settings

To change the gauge settings click **Setup** -> **Measurement Setup**. You can change the Units and Velocity.

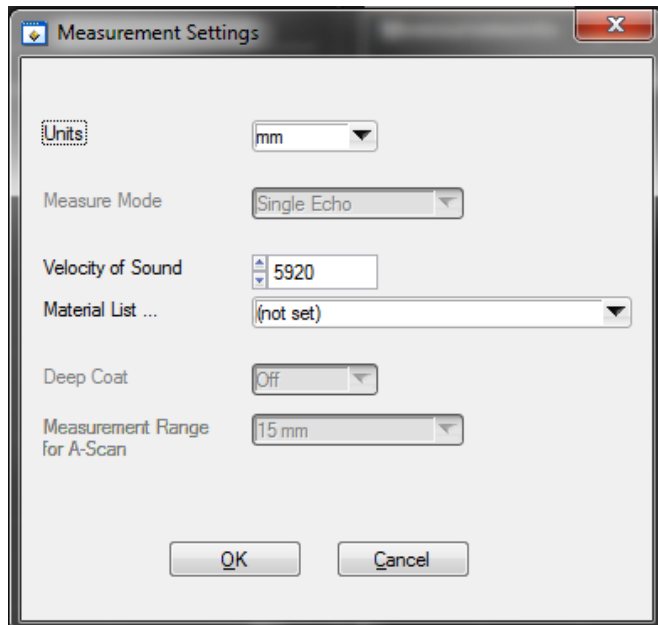

Measurement Settings Screens

Material Velocity List

You can select the Velocity from a list of common materials. In the Measurement **Settings** click on the [▼] next to **Material List** and a drop down list will appear click on the desired material.

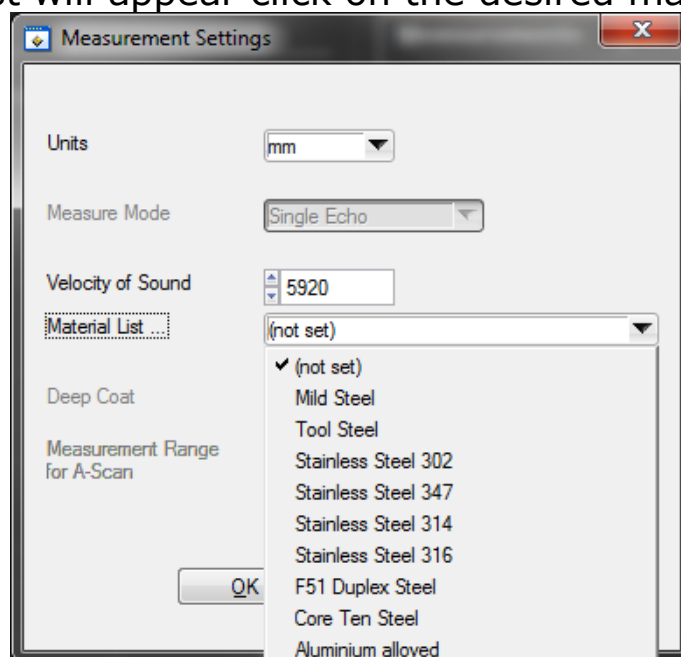

Velocity List

Calibrating to a Known Thickness using CygLink

The CygLink display can be calibrated to a known thickness by using the Gauge to measure a sample of the material that will be measured. This method ensures the velocity of sound is set for the actual material being measured rather than using a “generic” value.

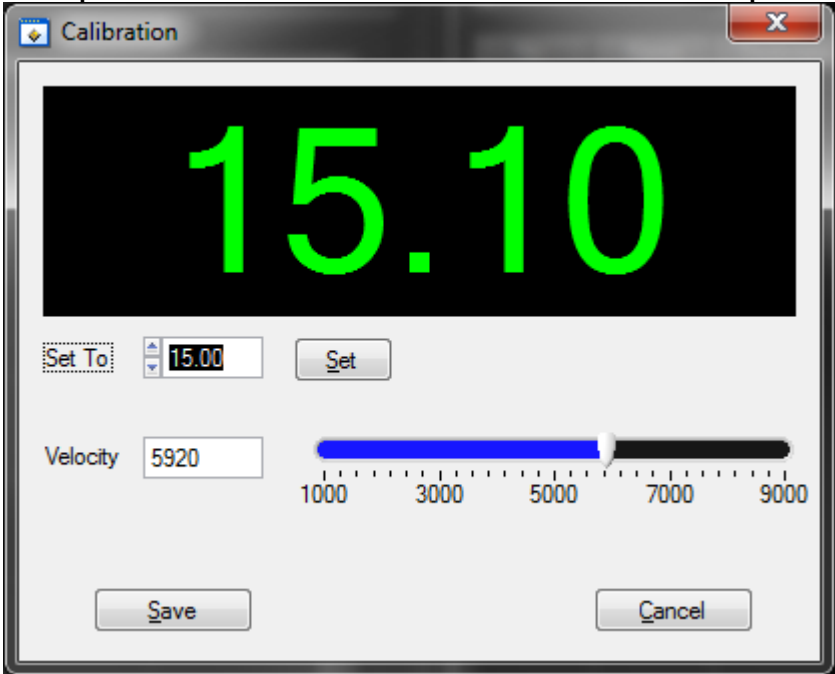
<p>1.</p>	<p>Place and <u>hold</u> the Gauge’s ultrasonic probe on the material sample using couplant if out of the water</p> <p>You should have a stable thickness measurement on the display</p>
<p>2.</p>	<p>Click Setup -> Calibrate Thickness Measurement. With the probe still held on the material sample.</p>  <p>Calibration Menu</p>
<p>3.</p>	<p>Select the value in the Thickness box and enter the known thickness of the sample being measured Press the Set and then Save</p>
<p>4.</p>	<p>Repeat from step 1 to check the calibration is stable.</p>

CygLink Surveys and Data Logging

CygLink has the facility to store logged thickness measurements in a single Survey file. These measurements are organised into Survey Groups, each Survey Group can contain any number of thickness measurements. The whole Survey can be saved to a single file which can be emailed, or turned into a PDF paper report.

Survey Groups Measurements 1 Survey (1 to many groups) (1 to many measurements)

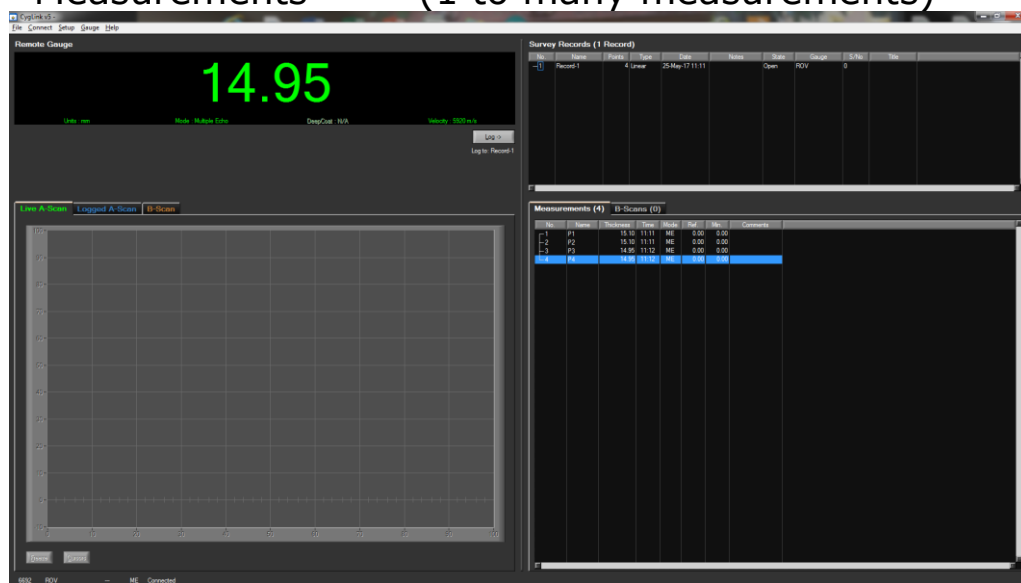

Right side of CygLink Main Screen with a Survey Group with Measurements.

You can Save, Open or Create new Surveys from the File menu;

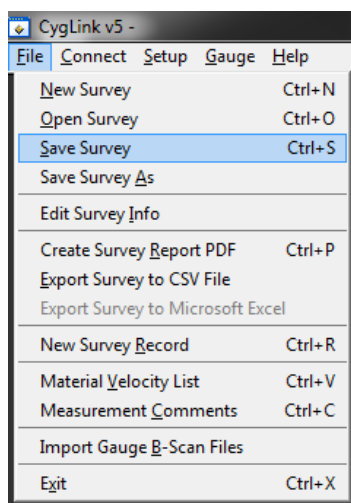

File Menu.

Editing the Survey Details

The Survey contains all the Groups and is used to save all the data. You can also add details to the Survey that will be printed at the beginning of the PDF report. To create or edit the Survey details click **File -> Edit Survey Details**.

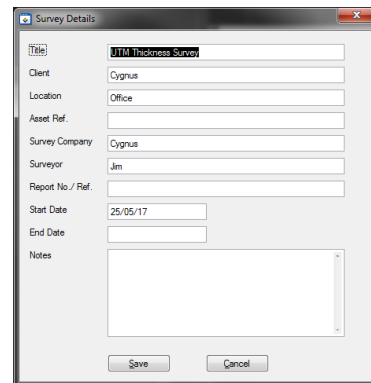

Survey Details Screen.

Editing the Survey Group Details

To view and edit the survey Group details right click the Survey Group and select properties.

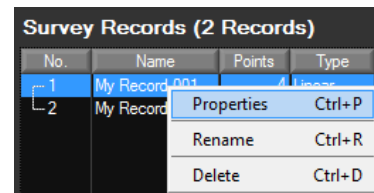

To create a new survey record click File and select **New Survey Record**. Here you can set and related information such as a Reference Thickness and Minimum Thickness.

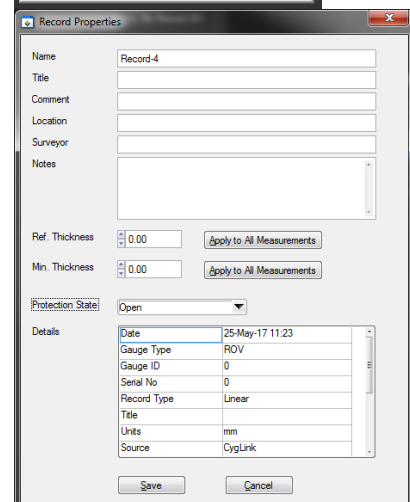
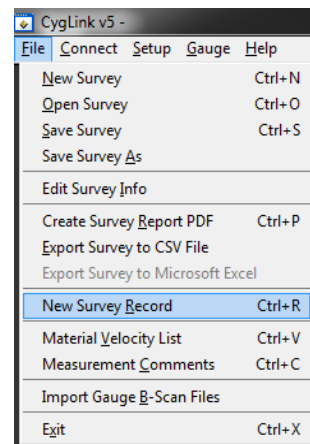

Reference and Minimum Thickness Criteria

You can set a Reference Thickness and Minimum Thickness for each survey Group in the **Survey Group Details** screen. This will be applied to all measurements in the Group.

The Reference Thickness is the thickness of metal when new.

The Minimum Thickness is the minimum thickness – any measurement below this will be highlighted Red on the screen and in the survey report.

Producing a Survey Report Document

A PDF report can be produced containing all the Groups and thickness measurements in the Survey, grouped by each Survey Group. From the **File** menu select **Create Survey Report PDF**. You will be prompted for a filename first for the report first.

Once the export process is complete, your report will automatically be displayed in your installed PDF viewer. The export may take a few seconds, depending on the number of logged measurements.

Logging Measurements Directly in CygLink

You can use CygLink to log the displayed topside thickness measurements into a Survey so they can be presented in the Survey report. To do this click the **Log** button below the thickness measurement.

Pre-Set Measurement Comments List

You can add up to 8 short text comments that can then be used to append to a thickness measurement. To setup your comments click **File -> Measurement Comments**.

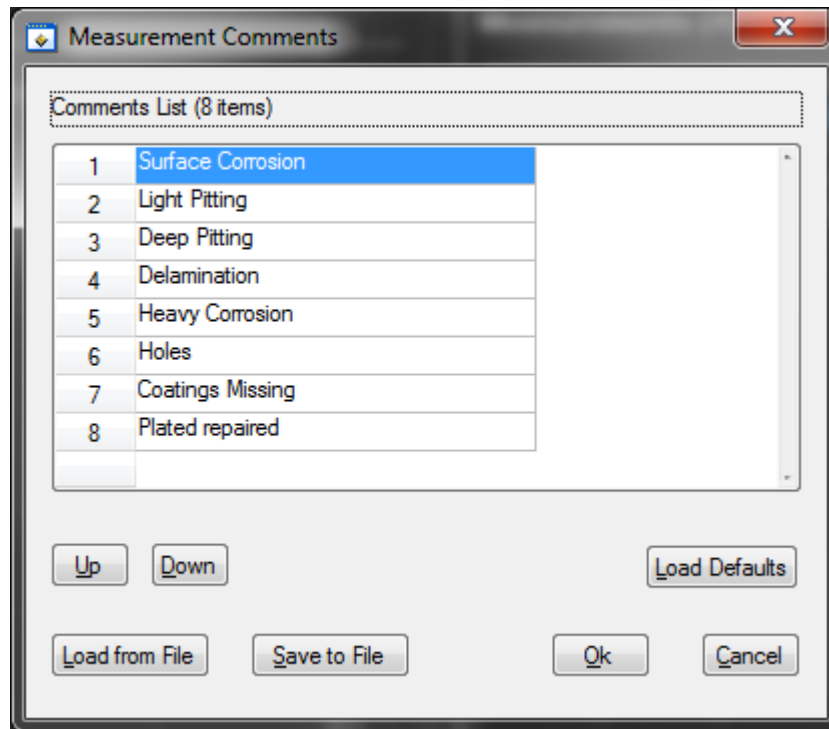

Measurement Comments Screen.

Adding Comments or Notes to a Measurement

You can add your own quick text Notes to any logged thickness measurement, just select the measurement point in the list and right click to display more options.

Click **Add Note** to type in a brief text note.

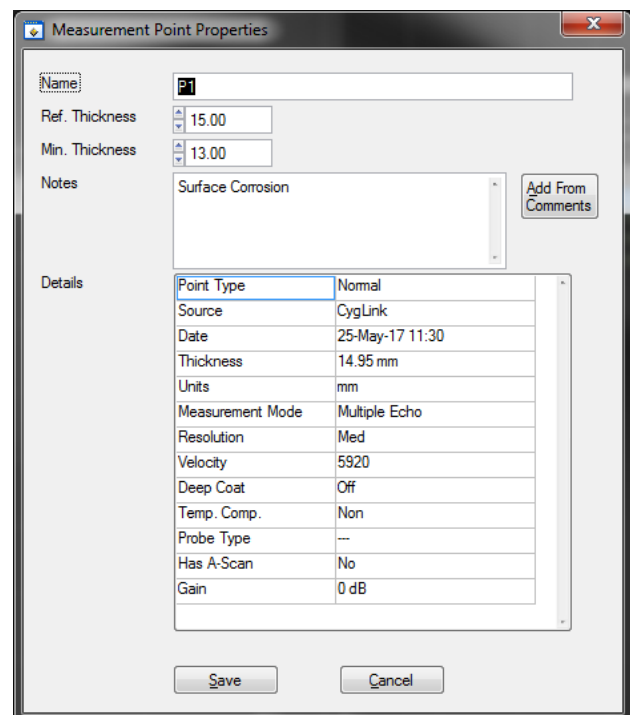

CygLink Trouble Shooting

Connection Problems – USB Drivers

If you are unable to get a connection the first thing to try is updating the USB drivers for the Serial to USB converter. Windows is constantly being updated and as a result drivers also need to be updated to keep track of changes.

The Serial to USB converter used for the ROV gauge is manufactured by KK Systems and uses Prolific drivers. You can search the web for the latest drivers from Prolific;

Type this into Google search "**KK SYSTEMS USB232**"

Or follow this link directly to the KK Systems website;

http://www.kksystems.com/english/html_files/software.htm
Follow the instructions for USB232 Windows Drivers;

Wiring Problems

Sometimes the cable between the ROV gauge and the USB converter is damaged, or has been repaired incorrectly. Although there are only 2 data wires they must be connected the correct way around. Double check the connections from the gauge's connector to the serial converter connection.

If you have the short serial to USB interface cable – check the gauge can connect to CygLink using this cable – if it works then the USB driver must be ok, the problem may lie in the long umbilical cable.

8. Probes & Membranes

 The Gauge should only be used with Soft-Faced probes supplied by Cygnus Instruments

Cygnus Soft-Faced probes are fitted with a Polyurethane Membrane which provides better contact on rough surfaces and protects the probe face from wear, prolonging the life of the probe.

Check the membrane regularly as it is important the membrane is changed as soon as it shows any signs of wear.

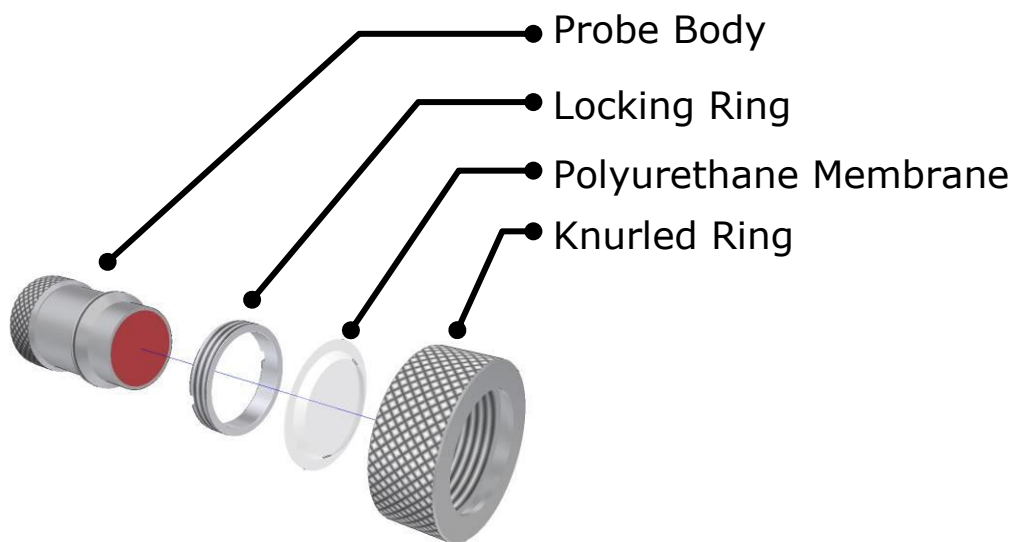





Probe Selection

Apart from the physical limitation of the probe size, the diameter of the probe face (crystal) and the frequency affects the probe performance. Generally:

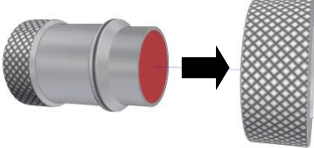
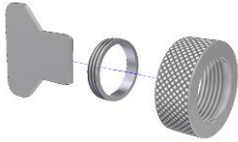
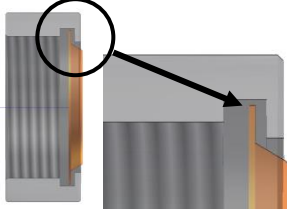
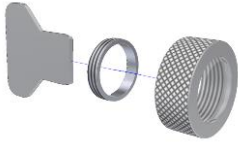
- Large diameter probes produce more energy which gives better performance on heavily corroded or coated materials
- Higher Frequency probes produce a narrower focused beam which is better when looking for small features or on thin materials

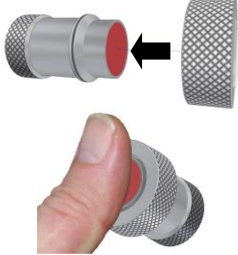
Changing the Membrane

<p>1.</p>	<p>Unscrew the Knurled Ring from the end of the Probe</p>	
<p>2.</p>	<p>Use the Locking Ring Key to unscrew the Locking Ring from inside the Knurled Ring. The old membrane can then be removed and discarded</p>	
<p>3.</p>	<p>Place a new membrane into the end of the Knurled Ring ensuring it locates in the groove</p>	
<p>4.</p>	<p>Screw the Locking Ring back inside the Knurled Ring and tighten with the Locking Ring Key</p>	
<p>5.</p>	<p>Place a few drops of Membrane Couplant on to the probe face</p>	
<p>6.</p>	<p>Screw the Knurled Ring back onto the probe. Use your thumb to squeeze the couplant from under the membrane as you tighten the Knurled Ring down</p>	
<p>7.</p>	<p>You should see the membrane has a very thin film of couplant between itself and the probe face with <u>no air bubbles</u></p>	

Probe Selection & Specifications

Crystal Diameter	Frequency	Measurement Range	Application
13 mm ½ inch	2¼ MHz	3.0 – 250 mm ¹ 0.12 – 10 inch	This is the standard probe – suitable for most applications
13 mm ½ inch	3½ MHz	2.0 – 150 mm 0.08 – 6 inch	Suitable for measurement on thinner sections where surfaces are relatively rough
6 mm ¼ inch	5 MHz	1.0 – 50 mm 0.04 – 2 inch	The higher frequency and narrower beam makes this probe ideal for measuring small-bore tubing, thin section plate and other areas where access is limited
13 mm ½ inch	5 MHz	1.0 – 50 mm 0.04 – 2 inch	Ideal for thin sections without heavy corrosion

Lower frequency probes offer better penetration on heavy corrosion or coatings.

Probe Frequency Identification

The frequency of Cygnus probes is indicated by colour;



Red = 2.25 MHz	Orange = 3.5 MHz	Black = 5.0 MHz
-----------------------	-------------------------	------------------------



¹ To measure thicknesses on tall thin cylinders or columns the height-width ratio should be no less than 1.0:0.6 (Height: Width) otherwise side reflections prevent measurement.

Mounting the Ultrasonic Probe

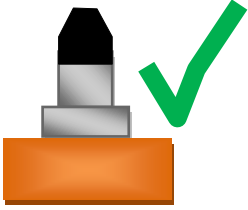
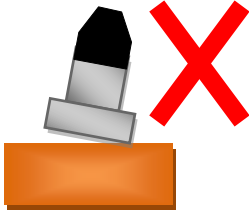
The Ultrasonic Probe is responsible for generating then transmitting and receiving the ultrasonic signal through the material being measured. To ensure the ultrasonic probe has the best chance of detecting the return echoes there are some basic rules that need to be considered when designing the probe holding tooling:

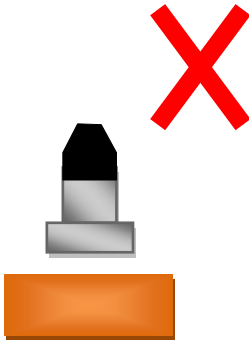
<p>1.</p>	<p>The probe face must be presented flat/perpendicular to the surface being measured</p>		
<p>2.</p>	<p>Apply gentle pressure to the probe while measuring to maintain contact with the surface</p>		

9. O-Ring Seals

Correct fitting of O-ring seals

There is one O-ring seal ('A') fitted to the nosecone and one O-ring seal ('B') fitted to the Gauge body.

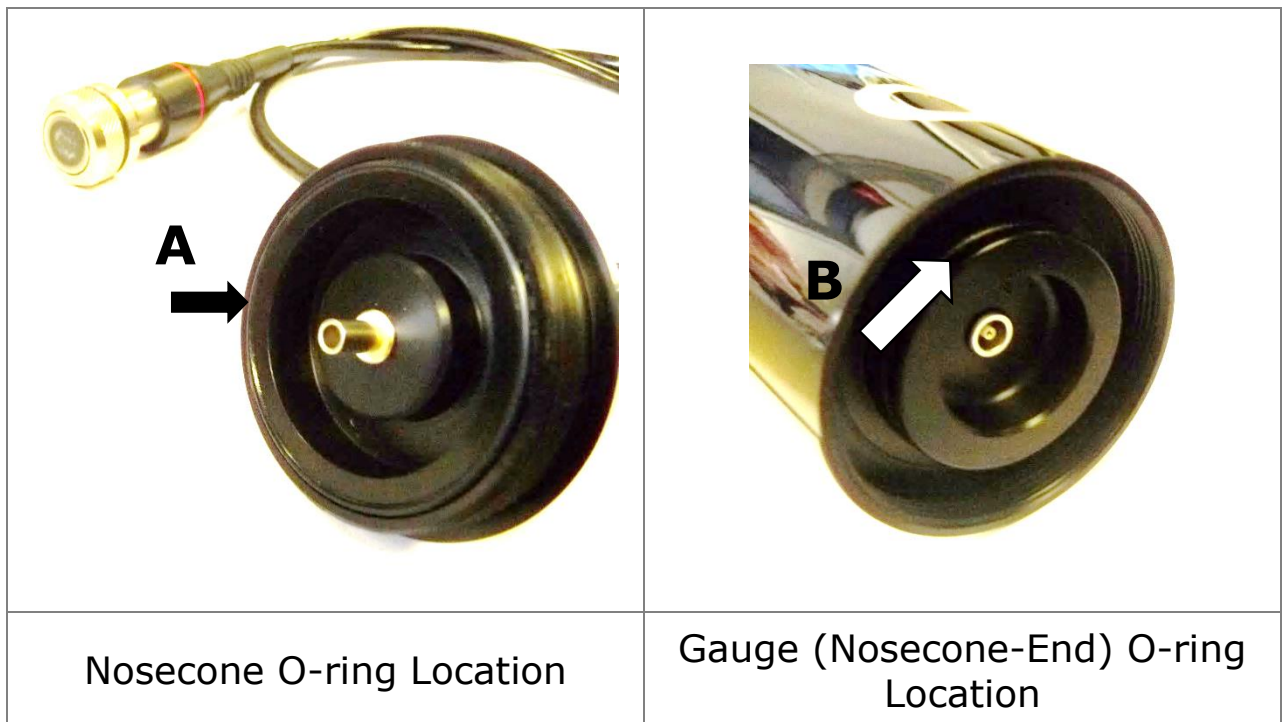

Cover both O-Rings with a light coating of Silicone grease, then fit as shown in the diagram above, where:

- 'A' is fitted into the O-Ring groove in the nosecone housing
- 'B' is to be fitted in the O-Ring groove at the front of the instrument

It is important to ensure that the O-Rings are properly located. There is no need to stretch or force the O-Rings into their locations. All parts are designed to ensure a good water-tight fit: **Incorrect fitting will result in the instrument leaking.**

-  • Be careful *not* to fit the 'A' O-ring in the wrong position, this is a common mistake that will cause incorrect gauge operation



- ❗ Only use the Torque Bar to *undo* the nosecone after each submersion.

Removing the Nosecone

The nosecone can be difficult to remove when the O-rings have been compressed so a Tommy Bar is supplied with the kit to allow extra leverage to be applied to 'break' the seal. Fit the Tommy Bar into the hole in the nosecone then unscrew using the Tommy Bar as a lever.

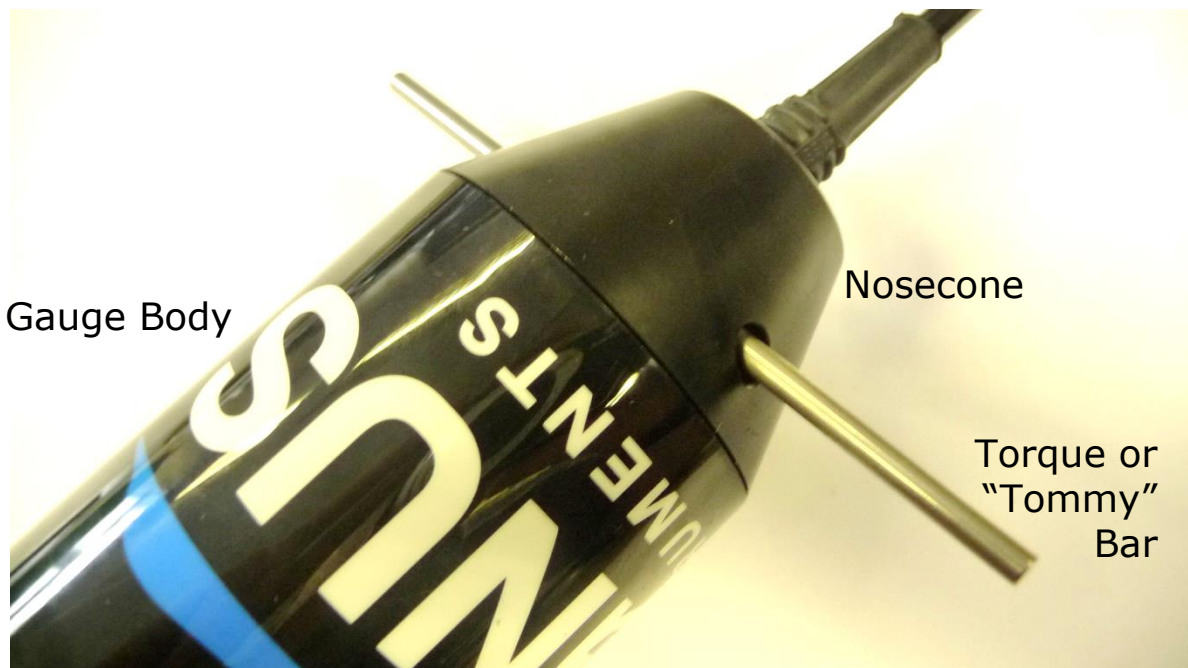

Replacing the O-Ring Seals

Spare O-rings are included in the kit, the different O-rings are marked A and B.

 <p>'O' - RINGS 'A' SEE MANUAL FOR CORRECT LOCATION</p>	 <p>'O' - RINGS 'B/D' SEE MANUAL FOR CORRECT LOCATION</p>	
<p>'A' O-rings (1 pack of 10)</p>	<p>'B' O-rings (1 pack of 10)</p>	<p>Silicone Grease</p>

1. Remove the old O-rings and destroy them
Do not use a sharp instrument to remove the O-rings as damage to the sealing area may occur
2. Clean the O-ring locations removing all grease and dirt
3. Pre-lubricate the new O-rings with Silicone grease
4. Gently fit the new O-rings into position (see page 40)

Checking the O-rings

To ensure the gauge remains water-tight these O-rings must be checked each time you remove the battery pack or nosecone. It is recommended to replace the O-rings if in any doubt as to their condition or age.

- ✓ Replace the O-rings at the start of a new job
- ✓ Replace the O-rings after every 2-3 submersions
- ✓ Check the O-rings whenever you remove the battery

- ✓ Check the O-rings whenever you remove the nosecone
- ✓ Always lubricate the O-rings with Silicone grease
- ✗ Do not use old or damaged O-rings
- ✗ Never use the Gauge without any O-rings fitted

Spare O-rings are included in the Kit and can be ordered from Cygnus Instruments (see page 8 for contact details).

Things to look for when inspecting the O-rings are:

- Any flats or signs of wear
- Any signs of pinching or trapping
- Any sand or dirt in the Silicone grease
- Any cuts or cracks

10. General Points on Thickness Gauging

On very rough surfaces and especially if both sides are badly corroded, it is often necessary to move the Probe around to locate a back wall reflector. Sometimes a slight rocking movement can help find reflectors which are otherwise impossible.

Beware that in extreme conditions or if the plate is of poor quality and contains many inclusions the ultrasound will be scattered to such an extent that measurement may not be possible.

Beware that the multiple-echo technique will not work if the front and back surfaces of the material being measured are not close to parallel. Also note that long narrow bars cannot be gauged along their length with the multiple-echo method.

The Gauge should not be used near arc-welding equipment, as this affects its performance.

11. Troubleshooting

Difficulty obtaining a Reading

If there is 1 single flashing bar on the display – this means the Gauge is not receiving any echoes:

- Check that the Probe-lead is properly connected to both Probe and Gauge
- Check the condition of the lead and replace if necessary

If there is mostly 1 fixed bar plus 1 flashing bar this means that the Gauge is having difficulty obtaining more than one echo:

- Check the Probe and its membrane are properly assembled.

If there are up to 3 fixed bars plus 1 flashing bar, but never any reading – this means the Gauge is receiving unrelated echoes from more than one reflector:

- On heavily corroded areas this is often a problem, try and take measurements in adjacent areas of the same material
- Check the Gauge and Probe together on a test block, if there is still no reading the Gauge may require servicing

If Readings are Erratic or Unstable

- Check that the Probe-lead is properly connected to both Probe and Gauge
- Check that the Probe and its membrane are correctly assembled with sufficient couplant between the probe face and membrane
- Check the Probe-frequency is suitable for the probable minimum thickness of the material being measured. Probe frequencies which are too low cause doubling and tripling of the actual thickness

12. The 3 Point Check

The most frequent reasons found to cause difficulty getting readings are:

1. Is the Probe-membrane fitted correctly?

- Check that there is a thin layer of oil between the membrane and Probe-face, and with *no air-bubbles* trapped. See Changing the Membrane on Page 37

2. Is the Probe-lead OK?

- Check the probe lead is in good condition and is correctly attached to the Gauge. See page 12

3. Is the material measurable at all?

- Are the front and back faces of the material parallel?
- Is the material too heavily corroded?
- Is the material too thin for the Probe being used? (See page 38)

It is often worth confirming that the Gauge is operating OK using a test sample, and also to confirm that the material can actually be measured by ultrasonic multiple-echo thickness measurement.

13. Care and Servicing

Cleaning the Gauge

- ✘ After each submersion, and while the instrument is still assembled, wash the unit in fresh water and allow to dry
- ✘ To maintain the water-tight integrity of the assembly : the Gauge should be disassembled after every submersion, and the O-Rings should be replaced with new
- ✘ Clean the O-Ring grooves, and ensure that there are no particles remaining - a mild detergent may be necessary to remove grease from the O-Ring grooves
- ✘ Care should be taken not to allow water into the instrument body whilst cleaning
- ✘ Do not use solvents for cleaning
- ✘ Do not use any abrasive cleaner

Use of O-Rings

- ✘ When reassembling before a submersion: always replace both O-Rings with new, first ensuring that they are lubricated with Silicone grease
- ✘ To avoid the risk of a leak: prevent accidental re-use by destroying all used O-Rings after each submersion

Data-link connector

- ✘ Always apply a coating of Silicone grease to the pins of the data-link connector before insertion into the socket on the Gauge
- ✘ If the Gauge is to be stored without the cable assembly connected, it is essential that the Blanking plug is inserted in the socket instead
- ✘ The pins of the Blanking Plug should also be lubricated with Silicone grease

Environmental

- ✘ Do not subject the Gauge to temperatures greater than 60°C (140°F)
- ✘ Do not store the Gauge and its kit for long periods in conditions of high humidity

Repairs

- ✘ Apart from the fuse there are no user serviceable parts inside the Gauge. Therefore all repair work should be carried out by Cygnus Instruments or by an Authorised Cygnus Service dealer

Returning the Gauge for Servicing

A full Manufacturer's Factory Service is available from Cygnus Instruments.

-  The Complete Kit should always be returned for Service or Repair, including all Probes and Leads.

Cygnus Gauges are renowned for their reliability, very often problems with getting measurements are simply due to the way the Gauge is being used. See Troubleshooting on Page 45.

However, if you do need to return your Gauge for Repair please let us know the details of the problem, to help us guarantee the best possible service:

- Is the problem of an Intermittent Nature?
- Is there a problem turning the Gauge On?
Or a problem with the Gauge turning itself off?
- Does the Gauge consistently give Incorrect or Unsteady Readings?
- Is it not possible to calibrate the Gauge?

14. Information

Technical Specifications

General Attributes		
Size	Gauge Body dimensions, excluding cabling: Length 160mm x Diameter 62mm (6.3 x 2.4 in.) Probe Cable length: 1m (39.4 in.)	
Weight In Air	With Remote Probe 550 grams (19.4 ounce)	
Power Supply	External 7.5 to 30 V DC 150mA Supply	
Operating Temperature Range	-10°C to +50°C (14°F to 122°F)	
Monitor Outputs	N/A	
Through Coating Measurements.	Coatings up to 3 mm thick as standard.	
Materials	Sound Velocity from 1000 m/s to 9995 m/s [0.0400 in/uS to 0.3998 in/uS]	
Measurement Range	Measurement Ranges in Steel: 2¼ MHz probe 3 mm to 250 mm [0.120 in. to 10.00 in.] 3½ MHz probe 2 mm to 150 mm [0.080 in. to 6.000 in.]	
Accuracy	±0.05 mm (±0.002")	High Resolution Mode and measurement <100.0 mm
	±0.1 mm (±0.005")	Low Resolution Mode or measurement >99.95 mm
Resolution	0.05 mm (0.002")	High Resolution Mode and measurement <100.0 mm
	0.1 mm (0.005") Selectable.	Low Resolution Mode or measurement >99.95 mm
Display		
Type of Display	Remote Display Unit	
Display Size	N/A	
Other Information		
Data Output.	RS-422 serial data output, 2400 Baud	
Calibration setting storage.	Calibration performed at Remote Display Unit	
Calibration Mechanisms.	N/A (Multiple Echo Gauge)	
Environmental Rating.	IP68 Rated to 500m (1640 ft) continuous immersion in sea water	
Compliance.	RoHS Compliant.	
Designed for	BS EN 15317	

15. Serial Data Format

The CygLink program and TSR are provided to automatically decode the measurement data sent from the Gauge, and to provide a calibrated display of the results. For users who want to display and log the data using their own software such as StarFix®, this section describes the arrangement of the data sent from the Gauge.

Note the Cygnus MINI ROV Gauge has a fixed Velocity of Sound value of 6400 m/s, you must re-scale the received thickness value for the velocity of sound required.

For example when measuring carbon steel with a velocity of 5920 m/s you will need to apply the following conversion factor:

$$\text{True Thickness} = \text{Received Thickness} * 5920/6400$$

Protocol

1. Unidirectional - Gauge transmits only
2. Eight Data bits, 1 Start bit, 1 Stop bit, No Parity; 2400 baud
3. Four packets per second
4. *Valid-Reading* packet-length : 7 bytes
5. *No-Reading* packet-length : 3 bytes

Valid Thickness Measurement Packet Arrangement

Byte	1	2	3	4	5	6	7
Name	SOH	Status	Data1	Data2	Data3	Data4	ETB
Type	1h		ASCII	ASCII	ASCII	ASCII	17h

No Thickness Measurement Packet Arrangement

Byte	1	2	3
Name	SOH	Status	ETB
Type	1h		17h

Status-byte Structure

Bit	Name	Details
7	Gauge Type	=1 (always)
6	Resolution	1 = High Resolution 0 = Low resolution
5	Units	0 = Metric mm 1 = Imperial Inch
4	Reading Range	1 = High Range 0 = Low Range
3, 2	Echo Count	Number of echoes found (0..3)
1	Calibration	1 = Remote (always)
0	No-Reading	1 = No Thickness Reading 0 = Valid Thickness Reading

Data-bytes Arrangement

The four data bytes are ASCII-encoded, decimal thickness value. Data byte 0 is most-significant. Leading-zeroes are replaced by ASCII Space [hex 20]. Decimal points are implied from the Status-byte – Units, Resolution and Range bits:

Reading-type	Hi-Range	Lo-Range
Imperial, Lo-Resolution	x x . x x	x . x x x
Metric, Lo-Resolution	x x x . x	x x x . x
Imperial, Hi-Resolution	x x . x x	x . x x x
Metric, Hi-Resolution	x x x . x	x x . x x

Interpreting the Readings sent from the Gauge

Decimal Point position	Decimal Point position is implied from the combination of Range, Resolution, and Units bits in the Status byte of each Reading [see table above]
Range	The Gauge returns all Readings in a 4-byte decimal string Readings which require 5-bytes [e.g. 100.00+mm, or 10.000+inch] are auto-ranged to the 4 most significant bytes Range bit for every Reading must be read from the Status-byte
Resolution	The Gauge is factory set to Lo-Resolution setting: 0.1 mm, or 0.005 inch but may be changed by the user to Hi-Resolution setting : 0.05 mm, or 0.002 inch as required
Units	The Gauge has a default Metric Units-setting. The Units bit must be read from the Status-byte

16. Table of Sound Velocities

Velocities will vary according to the precise grade and processing conditions of the material being measured.



This table is included as a guide only.

Wherever possible, the Gauge should always be calibrated on the material under test.



These Velocities are given in good faith and are believed to be accurate within the limits described above.

No liability is accepted for errors.

Velocities given are the compression wave velocity c_l .

Material	Velocity of Sound (V)		Conversion Factor (f)
	m/s	in/us	
Aluminium (alloyed)	6380	0.2512	1.078
Aluminium (2014)	6320	0.2488	1.068
Aluminium (2024 T4)	6370	0.2508	1.076
Aluminium (2117 T4)	6500	0.2559	1.098
Brass (CuZn40)	4400	0.1732	0.743
Brass (Naval)	4330	0.1705	0.731
Brass (CuZn30)	4700	0.1850	0.794
Copper	4700 - 5000	0.1850 - 0.1969	0.794 - 0.845
Grey Cast Iron	4600	0.1811	0.777
Inconel	5700	0.2244	0.963
Lead	2150	0.0846	0.363
Monel	5400	0.2126	0.912
Nickel	5630	0.2217	0.951
Phosphor Bronze	3530	0.1390	0.596
Mild Steel	5920	0.2331	1.000
Tool Steel	5870	0.2311	0.992
Stainless Steel 302	5660	0.2228	0.956
Stainless Steel 347	5790	0.2279	0.978
Stainless Steel 314	5715	0.2250	0.965
Stainless Steel 316	5750	0.2264	0.971

Material	Velocity of Sound (V)		Conversion Factor (f)
	m/s	in/us	
F51 Duplex Steel UNS S31803	5715 - 5750	0.225 - 0.2264	0.956 - 0.971
Core Ten Steel EN12223 S355-J0	5920	0.2331	1.00
Tin	3320	0.1307	0.561
Titanium	6100 - 6230	0.2402 - 0.2453	1.030 - 1.052
Tungsten Carbide	6660	0.2622	1.125
Epoxy Resin	2500	0.0986	0.422
Acrylic	2730	0.1076	0.461
Nylon (Polyamide)	2620	0.1032	0.443

Reading Conversions

If only a few measurements are to be taken on a material other than Steel, it may be easier to leave the calibration set for Steel and merely convert the readings by multiplying by the **Conversion Factor** for the material being measured.

This method avoids unnecessary recalibration.

Example: The Gauge is calibrated for Steel [5920 m/s], but the reading is being taken on Copper [4700 m/s] :

$$\begin{aligned}
 T &= t \times V_{\text{COPPER}} / V_{\text{STEEL}} \\
 &= t \times 4700 / 5920 \\
 &= \underline{t \times 0.794}
 \end{aligned}$$

thus: **T = t x f** [where: f = $V_{\text{COPPER}} / V_{\text{STEEL}}$]

where : **T = true thickness of Copper being measured**
t = actual reading obtained
f = Conversion Factor (from table)

V_{COPPER} = Sound Velocity in Copper : 4700 m/s
 V_{STEEL} = Sound Velocity in Steel : 5920 m/s

The **Conversion Factor f**: is given for various materials in the Table of Sound Velocities

17. Part Number & Accessories List

Gauges

Part No.	Description
001-7144/4	MINI ROV 500m ROV UTG Kit with 2.25MHz 13mm Probe
001-9944/4	MINI ROV 500m UTG Kit, without Probe

Surface/Topside Display

Part No.	Description
001-7153/4	TOPSIDE REPEATER Kit with Video On Screen Display for Cygnus MINI ROV

Software

Part No.	Description
001-8212	Cygnus CygLink v4 Topside Software on USB Flash Drive

Underwater Probes with 1 Metre Lead

All probes are fully assembled and include a spare membrane pack and knurled ring locking key.

Part No.	Description
001-8334	Probe 2.25MHz 13mm for MINI ROV (1m cable)
003-9410	Probe 2.25MHz 19mm for Cygnus MINI ROV

Lower frequency probes offer better penetration on heavy corrosion/coatings. Please refer to page 38 for correct probe selection.

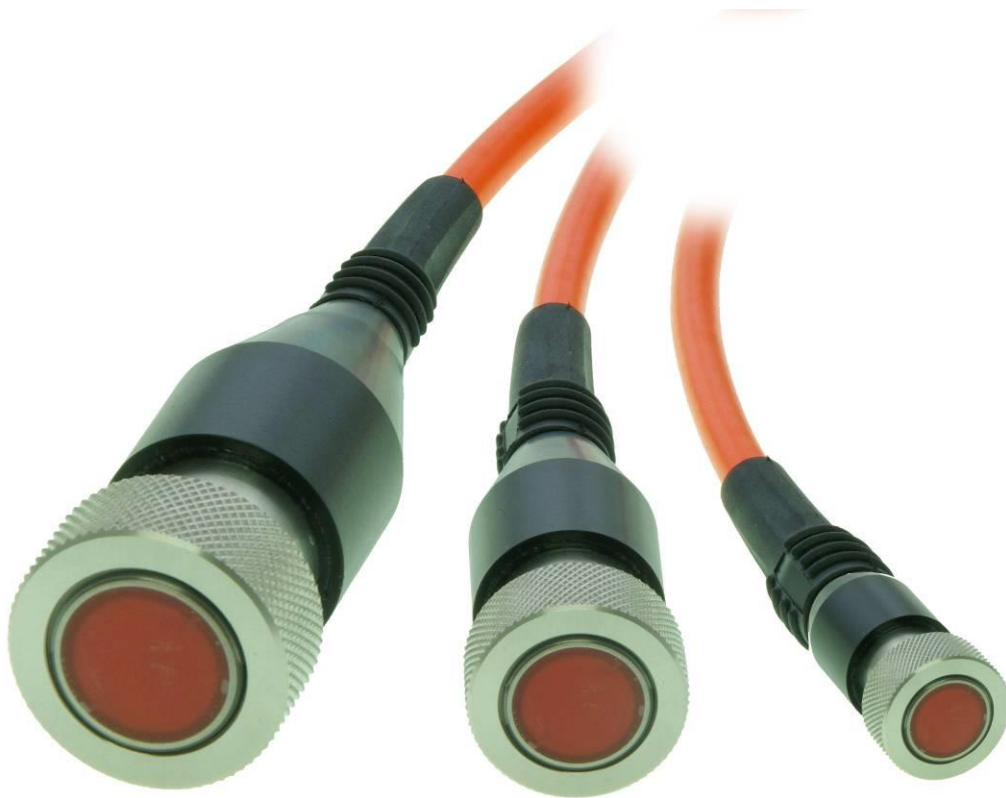

Probe Spares and Membranes

Polyurethane Membranes are for normal use on surface temperatures up to 75°C.

Teflon Membranes are for use on surface temperatures up to 150°C

Part No.	Description
001-3702	Pack of 20 Polyurethane Membranes for 6mm (1/4") Probes
001-3701	Pack of 20 Polyurethane Membranes for 13mm (1/2") Probes
001-3700	Pack of 20 Polyurethane Membranes for 19mm (3/4") Probes
001-4873	Pack of 10 Teflon Membranes for 6mm (1/4") Probes
001-4874	Pack of 10 Teflon Membranes for 13mm (1/2") Probes
001-4875	Pack of 10 Teflon Membranes for 19mm (3/4") Probes

Part No.	Description
001-3706	Membrane Couplant (25ml)
001-3708	UCA-2M Ultrasonic Couplant Gel (100ml)

Knurled Rings

Part No.	Description
001-3703	Knurled Ring Assembly for 6mm (1/4") Probes
001-3709	Knurled Ring Assembly for 13mm (1/2") INOX Probes
001-3704	Knurled Ring Assembly for 13mm (1/2") Probes
001-3705	Knurled Ring Assembly for 19mm (3/4") Probes
001-2612	Membrane Key for 6mm (1/4") Probes
001-2611	Membrane Key for 13mm (1/2") Probes
001-2610	Membrane Key for 19mm (3/4") Probes

Cables and Leads

Part No.	Description
001-0418	Impulse Connector 4-Way with Flying Lead
001-0432	Test Cable Impulse with DC Power for Mk3/4 ROV Gauges

Electronic Bodies Only

Part No.	Description
001-7190/4	Cygnus MINI ROV Mountable UTG Gauge Body
001-7181/4	Cygnus Topside Repeater (Instrument Body)

Miscellaneous Spares

Part No.	Description
001-4850	Steel Test Block 15 mm
001-4851	Steel Test Block 1/2"

Part No.	Description
01-4856	Carbon Steel Step Block 5-25mm in 5mm steps set in Perspex supplied with material type and dimensional accuracy traceable certificate.
001-8308	Isolated Data Converter RS422 to RS232 Model 'K3'
003-0422	RS232 to USB Serial interface cable
001-3712	'O' Ring Pack for Cygnus MINI ROV Mountable Gauge <i>Kit contents: 20 x 'O'-ring type A and 20 x 'O' Ring type B</i>
001-4813-ROV	Pelican Carry Case for Cygnus MINI ROV Gauge Kit

18. Recycling and Disposal (EC Countries)

The WEEE Directive (Waste Electrical and Electronic Equipment 2002/96.EC) has been put into place to ensure that products are recycled using best available treatment, recovery and recycling techniques to ensure human health and high environmental protection.

The Gauge has been designed and manufactured with high quality materials and components which can be recycled and reused. It may contain hazardous substances that could impact health and the environment. In order to avoid the dissemination of those substances in our environment and to diminish the pressure on natural resources we encourage you to dispose of this product correctly.



DO NOT dispose of this product with general household waste.

DO dispose of the complete product including cables, plugs and accessories in the designed WEEE collection facilities.

This product may also be returned to the agent or manufacturer who supplied it for safe end-of-life disposal.

19. Warranty Information

LIMITED THREE YEAR WARRANTY FOR CYGNUS ULTRASONIC THICKNESS GAUGES

1. Cygnus Instruments Limited ("CYGNUS") warrants that, subject as set out below, the Products manufactured by it (excluding consumables, batteries, probes, leads, microphones and telescopic extensions) will be free from defects in materials and workmanship for a period of three years from the date of purchase either from CYGNUS or from an Authorised CYGNUS Distributor. Batteries, probes, leads, microphones and telescopic extensions are warranted for 6 months. This warranty is limited to the original Purchaser of the Product and is not transferable. During the warranty period, CYGNUS will repair, replace or refund, at its option, any defective Products at no additional charge, provided that the product is returned by the original Purchaser, shipping prepaid, to CYGNUS or an Authorised CYGNUS Distributor. If shipped by mail or any common carrier, the Purchaser must insure and accept all liability for loss or damage to the Product and must use shipping containers equivalent to the original packaging. Replacement products or parts will be furnished on an exchange basis only. All replaced products or parts become the property of CYGNUS.
2. Any defects in materials or workmanship must be notified to CYGNUS by the Purchaser within seven days after the discovery of the defect or failure.
3. Dated proof of purchase must be provided by the Purchaser when requesting warranty work to be performed or making any other claim under this warranty. CYGNUS will not be liable under this warranty unless the total price for the Product was paid by the due date for payment.
4. This warranty does not extend to any products which have been damaged as a result of, accident, misuse or abuse, natural or personal disaster, service, modification or repair by anyone other than CYGNUS or an Authorised CYGNUS Service Centre, failure to properly store or maintain the Product, negligence, abnormal working conditions, fair wear and tear, or failure to follow the instructions issued by CYGNUS in relation to the Product.
5. Except as expressly set forth above or in the CYGNUS Terms of Sale, subject to which the Products were purchased, all warranties, conditions or other terms implied by Statute or Common Law are extended to the fullest extent permitted by law.
6. Except in respect of death or personal injury caused by the negligence of Cygnus, Cygnus shall not be liable to the Purchaser or to any other person by reason of any representation (unless fraudulent), or any implied warranty, condition or other term, or any duty at common law, or under the express terms of the contract for purchase of the Products, for loss of profit or for any indirect, special or consequential loss or damage, costs, expenses or other claims for compensation whatsoever (whether caused by the negligence of Cygnus, its employees or agents or otherwise) which arise out of or in connection with the supply of the Products or their use or resale by the Purchaser or by any other person. The entire liability of Cygnus under or in connection with the Products shall not exceed the price paid for the Products, except as expressly provided in this warranty.

20. Pressure Test Statement

All MINI ROV gauges are pressure tested in water as part of our test procedures.

Please refer to the environmental rating section for further information.

21. Independent Cable Connection

Recommended cable connection for direct cabling from Cygnus MINI ROV Gauge to surface computer

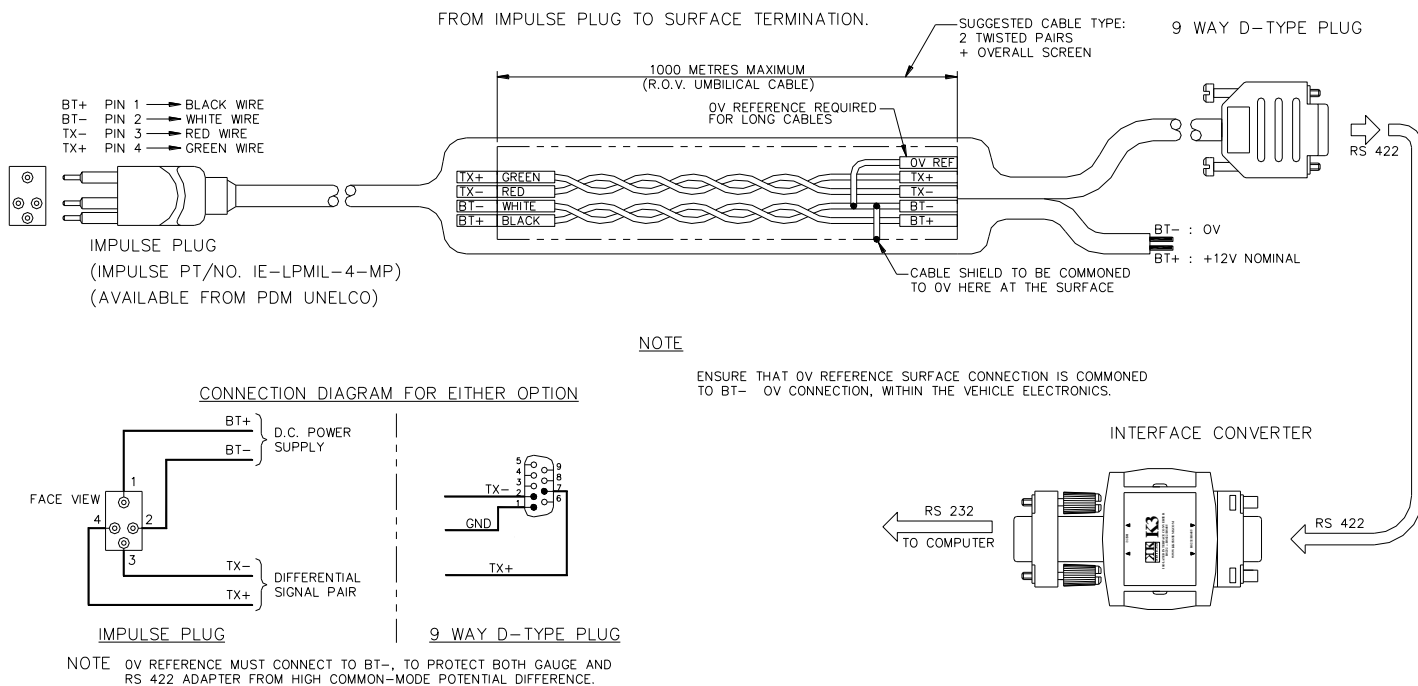

ⓘ **Cable-termination:** for long cables it may help to fit a 120 Ω resistor, in series with a 1nF capacitor, between the TX+ and TX- connections inside the 9-way D-type plug. See datasheets on the supplied USB Flash Drive for the K3 receiver, and MAX483 line driver.

22. ROV-Local Termination Connection

Recommended cable connection from Cygnus MINI ROV Gauge to ROV craft

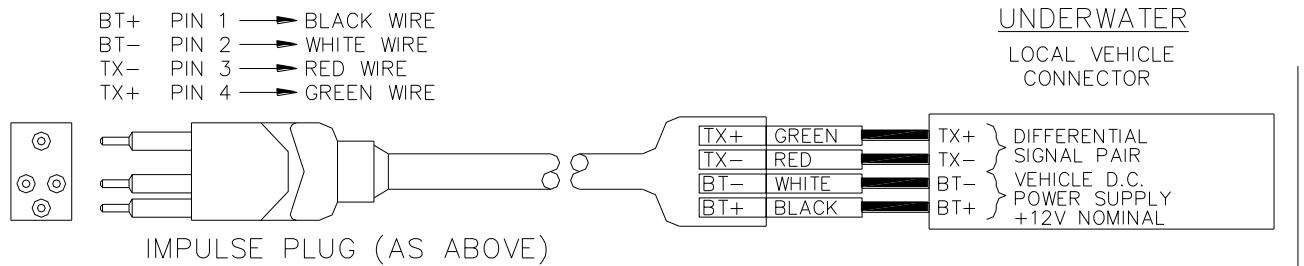

CONNECTION DIAGRAM FOR EITHER OPTION

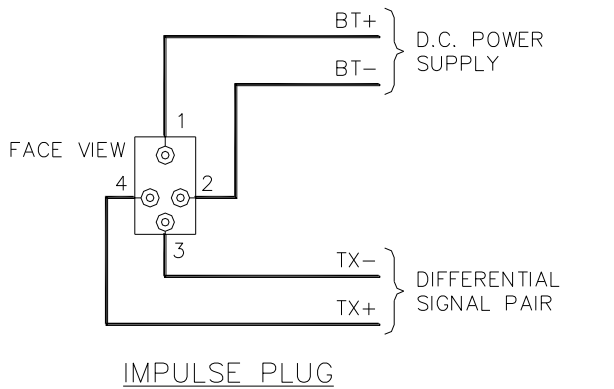

NOTE 0V REFERENCE MUST CONNECT TO BT-, TO PROTECT BOTH GAUGE AND RS 422 ADAPTER FROM HIGH COMMON-MODE POTENTIAL DIFFERENCE.

Recommended connection at surface, taken from ROV cabling to computer

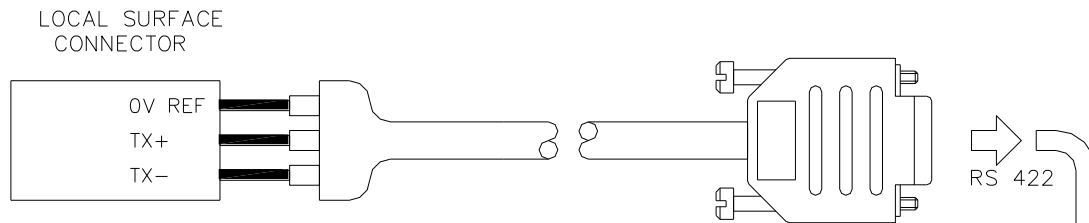

NOTE

ENSURE THAT OV REFERENCE SURFACE CONNECTION IS COMMONED TO BT- OV CONNECTION, WITHIN THE VEHICLE ELECTRONICS.

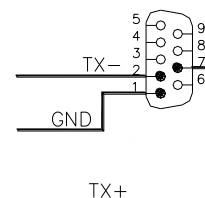
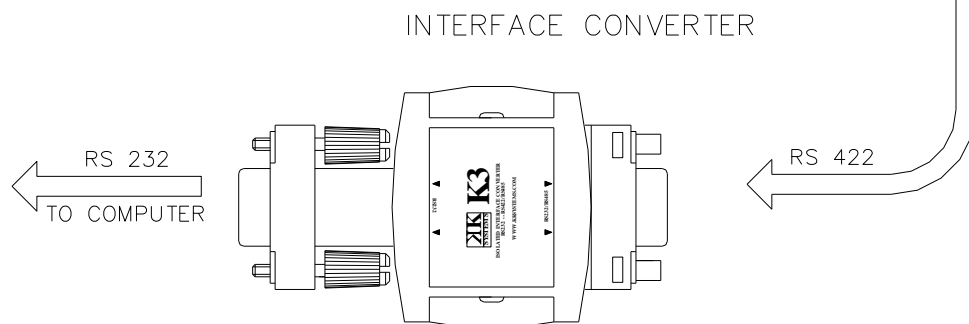

9 WAY D-TYPE PLUG

ⓘ *Alternatively - if you intend to convert the serial data sent from the Cygnus MINI ROV Gauge using your own electronics and/or software : the TX+ / TX- data-pair may be connected directly to any RS-422 compatible receiving equipment.*

23. Index

Accessories

- Cables and Leads, 57
- Electronic Bodies, 57
- Knurled Rings, 57
- Membrane Couplant, 57
- Miscellaneous Spares, 57
- Probe spares and membranes, 56
- Software, 55

Calibration

- Conversion Factor, 54
- Known Thickness, 18

Cleaning, 47

CygLink

- COM Port, 25
- Comment List, 33
- Comments, 34
- Connection to Gauge, 28
- Gauge Settings, 29
- Installation, 24
- Logging, 33
- Material Table, 29
- PDF, 33

Data Output, 14

Disposal, 59

Measuring Through Water, 16

Nosecone

- Removing, 41

O-Rings

- Checking, 42
- Molykote, 42
- Replacing, 41

Power Supply, 14

Probes

- Knurled Ring, 37
- Locking Ring Key, 37
- Membrane Couplant, 37
- Polyurethane Membrane Membrane, 36
- Selection, 36
- Specifications, 38

Problems, 48

Pulse-echo, 7

Recycling, 59

Repair, 48

Rough surfaces, 44

Serial Data Format, 50

Service, 48

Sound Velocities, 53

Specifications, 53

Test block, 18

Tommy Bar, 41

Top Side Repeater, 19

Topside Repeater

- Automatic Display Backlight, 20
- Display Units, 19, 20, 30
- HOLD, 20

Triple Echo Verification, 7

Troubleshooting, 45

Unrelated echoes, 45

Video Overlay, 20

Warranty, 60

WEEE Directive, 59